



EUROFINS PRODUCT TESTING SERVICE (SHANGHAI) CO., LTD

EMC TEST- REPORT

TEST REPORT NUMBER: EFSH18100030-IE-01-E01



Eurofins Product Testing Service (Shanghai) Co., Ltd
No. 395 West Jiangchang Road, Jing'an District,
Shanghai, 200436, P.R. China

Phone: +86-21-61819181
Fax: +86-21-61819299
Page 1 of 40

TABLE OF CONTENTS

1 Contents

| | | |
|----------|--|-----------|
| 1 | Contents | 2 |
| 2 | General Information | 3 |
| 2.1 | Notes | 3 |
| 2.2 | Testing laboratory | 4 |
| 2.3 | Details of approval holder | 5 |
| 2.4 | Application details | 5 |
| 2.5 | EUT information | 5 |
| 2.6 | Test standards | 6 |
| 3 | Technical test | 7 |
| 3.1 | Summary of test results | 7 |
| 3.2 | Test environment | 7 |
| 3.3 | Test mode | 7 |
| 3.4 | List of Test equipment | 8 |
| 3.5 | Test results | 10 |
| 4 | Emission Test | 11 |
| 4.1 | Conducted Emission | 11 |
| 4.2 | Radiated electromagnetic disturbances | 16 |
| 4.3 | Radiated disturbance | 23 |
| 4.4 | Voltage Changes, Voltage Fluctuations and Flicker | 28 |
| 5 | Immunity Test | 30 |
| 5.1 | Performance Criteria Description in Clause 4 of EN 61547 | 30 |
| 5.2 | Conditions during testing | 30 |
| 5.3 | ESD | 31 |
| 5.4 | Radio frequency electromagnetic fields | 32 |
| 5.5 | Electrical Fast Transients | 33 |
| 5.6 | Injected currents(RF continues conducted) | 34 |
| 5.7 | Surge Immunity | 35 |
| 5.8 | Voltage dips and Interruption | 36 |
| 6 | Test setup Photos | 37 |

2 General Information

2.1 Notes

The results of this test report relate exclusively to the item tested as specified in chapter “Description of test item” and are not transferable to any other test items.

Eurofins Product Testing Service (Shanghai) Co., Ltd. is not responsible for any generalisations and conclusions drawn from this report. Any modification of the test item can lead to invalidity of test results and this test report may therefore be not applicable to the modified test item.

The test report may only be reproduced or published in full. Reproducing or publishing extracts of the report requires the prior written approval of the Eurofins Product Testing Service (Shanghai) Co., Ltd.

This document is subject to the General Terms and Conditions and the Testing and Certification System of Eurofins Product Testing Service (Shanghai) Co., Ltd. available on request or accessible at www.pt.eurofins.com.

Operator:

| | | | |
|------------|---------------|-----------------------------|---|
| 2018-10-24 | | Perry Li / Testing Engineer |  |
| <hr/> | | | |
| Date | Eurofins-Lab. | Name / Title | Signature |

Technical responsibility for area of testing:

| | | | |
|------------|----------|--------------------------------|---|
| 2018-10-24 | | Stefan Zhao / Project Engineer |  |
| <hr/> | | | |
| Date | Eurofins | Name / Title | Signature |

2.2 Testing laboratory

Eurofins Product Testing Service (Shanghai) Co., Ltd

No. 395 West Jiangchang Road, Jing'an District, Shanghai, 200436, P.R. China

Telephone : +86-21-61819181

Fax : +86-21-61819299

Test location, where different:

Name : Shenzhen SEM.Test Technology Co., Ltd.

Address : 1/F., Room 101, Building 1, Hongwei Industrial Park, Liuxian'er Road, Block 70,
Bao'an District, Shenzhen, Guangdong, China

Telephone : +86-755-3366 3308

Fax : +86-755-3366 3309

All items were prepared and tested at Shenzhen SEM.Test Technology Co., Ltd.

2.3 Details of approval holder

Name : Foshan Electrical and Lighting Co., Ltd
 Address : 64 North Fenjiang Road, Foshan, Guangdong, China
 Telephone : ./.
 Fax : ./.

2.4 Application details

Date of receipt of application : 2018-10-15
 Date of receipt of test item : 2018-10-16
 Date of test : 2018-10-16 to 2018-10-22

2.5 EUT information

Product type : LED Lamps
 Model name : G45-5.5-*/G11F/112, G45-5.5-*/G12F/112,
 G45-5.5-*/G13F/112, G45-5.5-*/G14F/112,
 C37-5.5-*/G11F/112, C37-5.5-*/G12F/112,
 C37-5.5-*/G13F/112, C37-5.5-*/G14F/112.
 (The "*" means colour temperature, it can be integer number from 18 to 65, indicating the colour temperature is 1800K to 6500K)
 Brand name : FSL
 Serial number : ./.
 Ratings : 220-240V~, 50/60Hz, 5.5W
 See model list
 Test voltage : AC 230V, 50Hz
 Additional information :

- All models are self-ballasted LED lamp, and models G45-5.5-*/G11F/112, G45-5.5-*/G12F/112, G45-5.5-*/G13F/112, G45-5.5-*/G14F/112 are identical except for cap and appearance. Models C37-5.5-*/G11F/112, C37-5.5-*/G12F/112, C37-5.5-*/G13F/112, C37-5.5-*/G14F/112 are identical except for cap and appearance.

| Model | Rating | Lamp Cap |
|--------------------|---|----------|
| C37-5.5-*/G11F/112 | 220-240V~, 50/60 Hz, 5.5W, 45mA, non-dimmable | E14 |
| C37-5.5-*/G12F/112 | 220-240V~, 50/60 Hz, 5.5W, 45mA, non-dimmable | E27 |
| C37-5.5-*/G13F/112 | 220-240V~, 50/60 Hz, 5.5W, 45mA, non-dimmable | B22 |
| C37-5.5-*/G14F/112 | 220-240V~, 50/60 Hz, 5.5W, 45mA, non-dimmable | B15d |
| G45-5.5-*/G11F/112 | 220-240V~, 50/60 Hz, 5.5W, 45mA, non-dimmable | E14 |
| G45-5.5-*/G12F/112 | 220-240V~, 50/60 Hz, 5.5W, 45mA, non-dimmable | E27 |
| G45-5.5-*/G13F/112 | 220-240V~, 50/60 Hz, 5.5W, 45mA, non-dimmable | B22 |
| G45-5.5-*/G14F/112 | 220-240V~, 50/60 Hz, 5.5W, 45mA, non-dimmable | B15d |

- Models G45-5.5-27/G12F/112 and C37-5.5-27/G12F/112 are selected to test full items.

2.6 Test standards

Technical standard :

EN 55015:2013+A1:2015

EN 61547:2009

EN 61000-3-2:2014

EN 61000-3-3:2013

3 Technical test

3.1 Summary of test results

No deviations from the technical specification(s) were ascertained in the course of the tests performed.



or

The deviations as specified were ascertained in the course of the tests performed.



3.2 Test environment

| | | | | |
|---------------------------|---|-----|-----|--------|
| Temperature | : | 20 | ... | 24°C |
| Relative humidity content | : | 30 | ... | 55% |
| Air pressure | : | 100 | ... | 103kPa |

3.3 Test mode

Lighting

3.4 List of Test equipment

| Equipment Name | Manufactory | Model | Serial No. | Cal Due date |
|--|-----------------------|----------------------|------------|--------------|
| Spectrum Analyzer | Rohde & Schwarz | FSP | 836079/035 | 2019-06-11 |
| EMI Test Receiver | Rohde & Schwarz | ESVB | 825471/005 | 2019-06-11 |
| Amplifier | Agilent | 8447F | 3113A06717 | 2019-06-11 |
| Trilog Broadband Antenna | Schwarz beck | VULB9163 | 9163-333 | 2019-06-07 |
| Loop Antenna | EVERFINE | LLA-2 | 711001 | 2019-06-07 |
| Clamp | Luthi | MDS21 | 3809 | 2019-06-22 |
| EMI Test Receiver | Rohde & Schwarz | ESCI | 101611 | 2019-06-11 |
| Pulse Limiter | Rohde & Schwarz | ESH3-Z2 | 100911 | 2019-06-11 |
| AC LISN | Schwarz beck | NSLK8126 | 8126-224 | 2019-06-11 |
| Digital Power Analyzer | California Instrument | CTS | 72831 | 2019-06-11 |
| Power Source | California Instrument | 5001IX-CTS-400 | 25965 | 2019-06-11 |
| Horn Antenna | ETS | 3117 | 00086197 | 2018-06-07 |
| Pre-amplifier | Compliance Direction | PAP-0118 | 24002 | 2019-06-11 |
| ESD Generator | LIONCEL | ESD-203B | 0170901 | 2019-08-14 |
| Transient 2000 | EMC PARTNER | TRA2000 | 863 | 2019-06-11 |
| Couple Clamp | EMC PARTNER | CN-EFT1000 | CH-4242 | 2019-06-11 |
| CDN | Luthi | CDNL-801 | 2655 | 2019-06-11 |
| Attenuator | EMCI | MA-5100/6BF2 | 1009 | 2019-06-11 |
| CS Immunity Tester | SCHAFFNER | NSG2070 | 1123 | 2019-06-11 |
| Signal Generater | R&S | SMB100A | 105942 | 2019-09-10 |
| RF Power Amplifier | BONN Elektronik | BLWA0830-160/100/40D | 128740 | 2019-09-10 |
| RF Power Amplifier | NJNT | NTWPAS-2560025 | 2560025 | 2019-09-10 |
| Gestockte Breitband(S tacked) Log.-per.Antenna | SCHWARZBECK | STLP9128D | 043 | 2019-09-10 |

Test Report No.: EFSH18100030-IE-01-E01

| | | | | |
|-------------------------|-------------|----------------|--------|------------|
| Broad-band Horn Antenna | SCHWARZBECK | BBHA 9120 D | 667 | 2019-09-10 |
| Power Meter | R&S | NRP2 | 102031 | 2019-09-10 |

3.5 Test results

 1st test

 test after modification

 production test

| Test case | Sub clause | Required | Test passed | Test failed |
|---|---|-------------------------------------|-------------------------------------|--------------------------|
| Conducted Emission | Clause 4.3 of EN 55015 | <input checked="" type="checkbox"/> | <input checked="" type="checkbox"/> | <input type="checkbox"/> |
| Radiated electromagnetic disturbances | Clause 4.4 of EN 55015 | <input checked="" type="checkbox"/> | <input checked="" type="checkbox"/> | <input type="checkbox"/> |
| Radiated disturbance | Clause 4.4.2 of EN 55015 | <input checked="" type="checkbox"/> | <input checked="" type="checkbox"/> | <input type="checkbox"/> |
| Harmonic Current Emissions | EN 61000-3-2 | <input type="checkbox"/> | <input type="checkbox"/> | <input type="checkbox"/> |
| Voltage Changes, Voltage Fluctuations and Flicker | EN 61000-3-3 | <input checked="" type="checkbox"/> | <input checked="" type="checkbox"/> | <input type="checkbox"/> |
| Electrostatic Discharge | Clause 5.2 of EN 61547 & IEC 61000-4-2 | <input checked="" type="checkbox"/> | <input checked="" type="checkbox"/> | <input type="checkbox"/> |
| Radio frequency electromagnetic fields | Clause 5.3 of EN 61547 & IEC 61000-4-3 | <input checked="" type="checkbox"/> | <input checked="" type="checkbox"/> | <input type="checkbox"/> |
| Power frequency magnetic fields | Clause 5.4 of EN 61547 & IEC 61000-4-8 | <input type="checkbox"/> | <input type="checkbox"/> | <input type="checkbox"/> |
| Electrical Fast Transients | Clause 5.5 of EN 61547 & IEC 61000-4-4 | <input checked="" type="checkbox"/> | <input checked="" type="checkbox"/> | <input type="checkbox"/> |
| Injected currents (RF common mode) | Clause 5.6 of EN 61547 & IEC 61000-4-6 | <input checked="" type="checkbox"/> | <input checked="" type="checkbox"/> | <input type="checkbox"/> |
| Surge immunity | Clause 5.7 of EN 61547 & IEC 61000-4-5 | <input checked="" type="checkbox"/> | <input checked="" type="checkbox"/> | <input type="checkbox"/> |
| Voltage dips and short interruption | Clause 5.8 of EN 61547 & IEC 61000-4-11 | <input checked="" type="checkbox"/> | <input checked="" type="checkbox"/> | <input type="checkbox"/> |

Note:

1. Power frequency magnetic fields test was not required as the EUT did not contained components susceptible to magnetic fields.
2. The EUT is LED light power < 25W, which doesn't belong to discharge lighting equipment, thus harmonic current emission test is not applicable according to EN 61000-3-2 requirement.

4 Emission Test

4.1 Conducted Emission

This clause lays down the general requirements for the measurement of disturbance voltage produced at the terminals of apparatus.

4.1.1 Limits

| Frequency range MHz | At mains terminals dB (μ V) | |
|------------------------|-------------------------------------|----------|
| | Quasi-peak | Average |
| 0.009 to 0.05 | 110 | -- |
| 0.05 to 0.15 | 90 to 80 | -- |
| 0.15 to 0.50 | 66 to 56 | 56 to 46 |
| 0.50 to 5 | 56 | 46 |
| 5 to 30 | 60 | 50 |

Note1: The limit decreases linearly with the logarithm of the frequency in the range 50k to 150kHz and 150 kHz to 0.5 MHz.

Note2: The lower limit is applicable at the transition frequency.

4.1.2 Measurement procedure

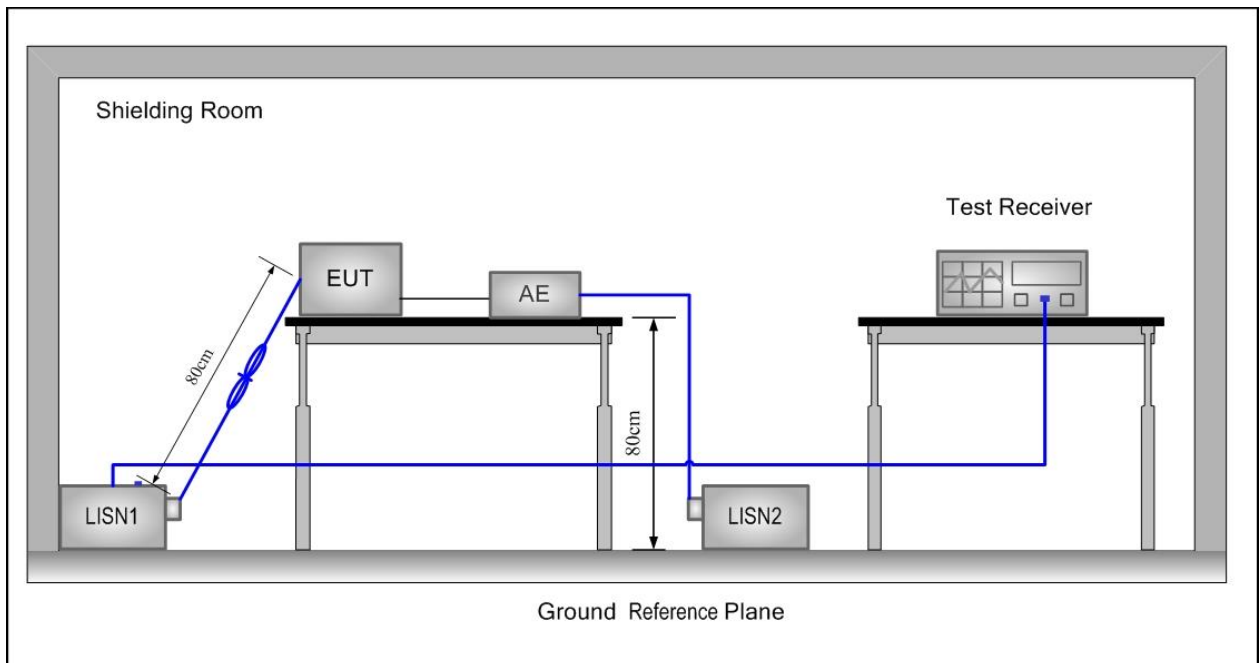

1. The mains terminal disturbance voltage was measured with the EUT in a shielded room.
2. The EUT was connected to AC power source through a LISN (Line Impedance Stabilization Network) which provides a $(50 \mu\text{H} + 5 \Omega) \parallel 50 \Omega$ linear impedance. The power cables of all other units of the EUT were connected to a second LISN, which was bonded to the ground reference plane in the same way as the LISN for the unit being measured.

- The table top EUT was placed upon a non-metallic table 0.8m above the ground reference plane. And for floor-standing arrangement, the EUT was placed on the horizontal ground reference plane, but separated from metallic contact with the ground reference plane by 0.1m of insulation.
- Before get the final emission results with quasi-peak(QP) detector and average(AV) detector, a pre-scan was performed with the peak(PK) and average(AV) detector to find out the maximum emission data plots of the EUT.

4.1.3 Measurement uncertainty

U_{lab}(cond) = 1.8dB at 95% level of confidence, k=2

4.1.4 Results -Measurement Data

Model G45-5.5-27/G12F/112

| | | | |
|-----------------------------|------------------------|----------------------|--------------|
| Job No.: | CE | Phase: | L1 |
| Standard: | EN55015 Conduction(QP) | Power Source: | AC 230V/50Hz |
| Test item: | Conduction Test | Date: | 2018/10/18 |
| Temp.(°C)/Hum.(%RH): | 23.5°C/55%RH | Time: | 15:13:29 |
| Note: | | | |

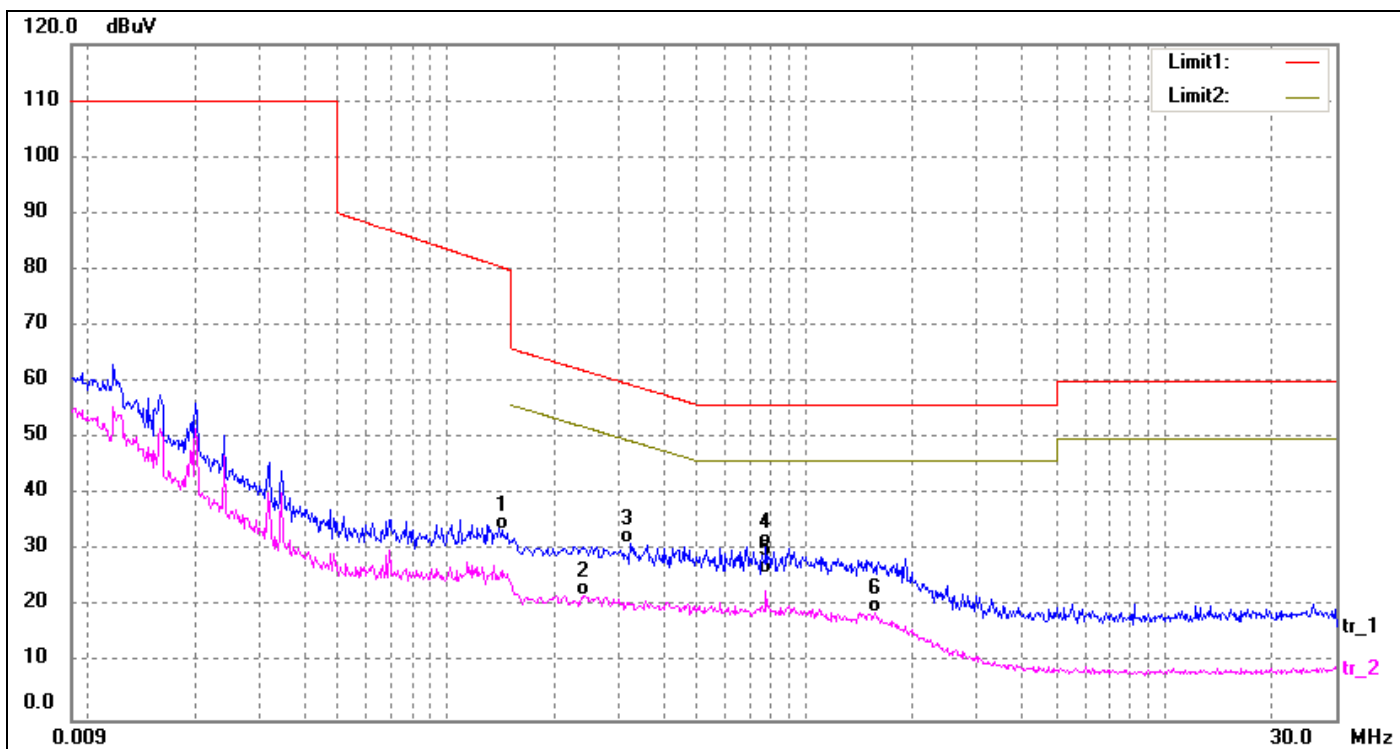

| No. | Frequency (MHz) | Reading (dBuV) | Correct (dB) | Result (dBuV) | Limit (dBuV) | Over (dB) | Detector |
|-----|-----------------|----------------|--------------|---------------|--------------|-----------|----------|
| 1 | 0.1423 | 23.59 | 10.10 | 33.69 | 80.48 | -46.79 | QP |
| 2 | 0.2420 | 11.92 | 10.15 | 22.07 | 52.03 | -29.96 | AVG |
| 3 | 0.3260 | 21.01 | 10.20 | 31.21 | 59.55 | -28.34 | QP |
| 4 | 0.7780 | 20.31 | 10.42 | 30.73 | 56.00 | -25.27 | QP |
| 5* | 0.7780 | 15.40 | 10.42 | 25.82 | 46.00 | -20.18 | AVG |
| 6 | 1.5540 | 8.55 | 10.56 | 19.11 | 46.00 | -26.89 | AVG |

Test Report No.: EFSH18100030-IE-01-E01

Eurofins Product Testing Service (Shanghai) Co., Ltd
No. 395 West Jiangchang Road, Jing'an District, Shanghai, 200436, P.R. China

| | | | |
|-----------------------------|------------------------|----------------------|--------------|
| Job No.: | CE | Phase: | N |
| Standard: | EN55015 Conduction(QP) | Power Source: | AC 230V/50Hz |
| Test item: | Conduction Test | Date: | 2018/10/18 |
| Temp.(°C)/Hum.(%RH): | 23.5°C/55%RH | Time: | 15:20:00 |
| Note: | | | |

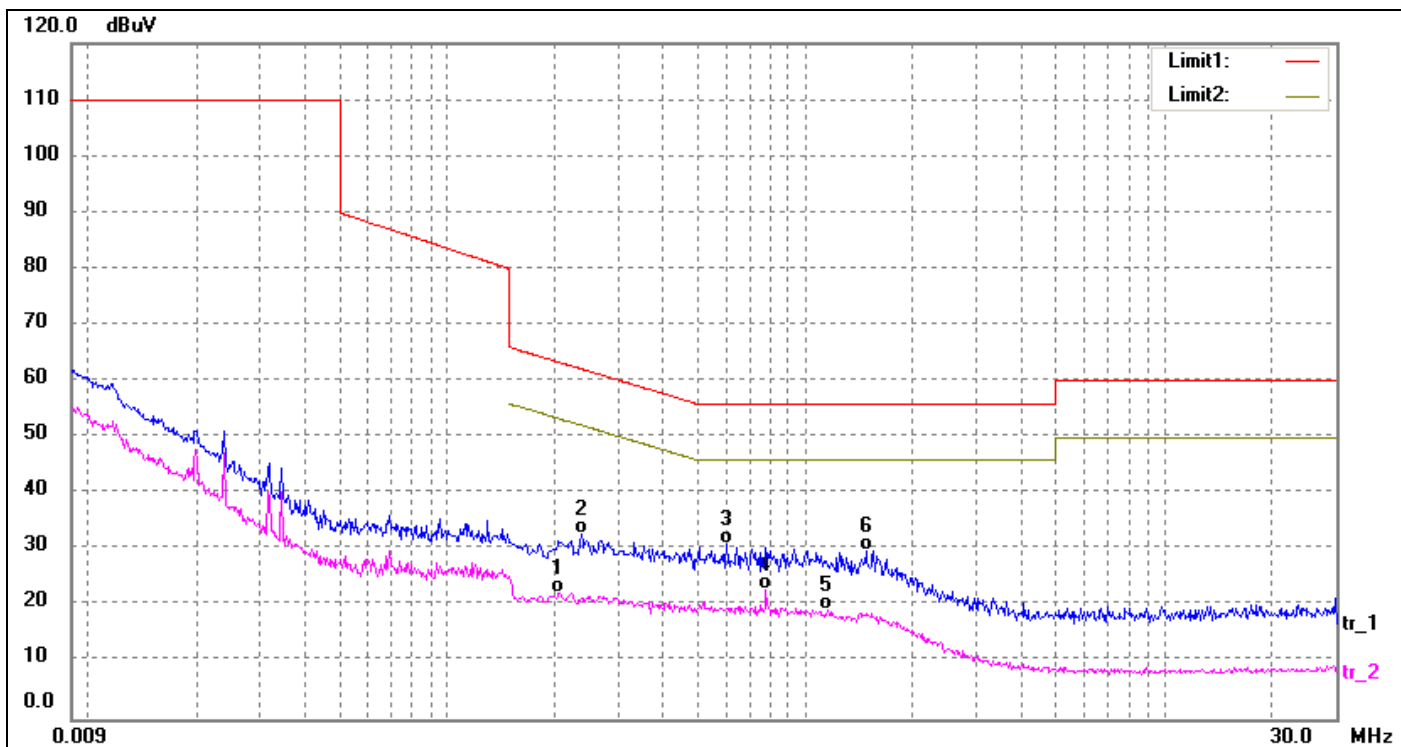

| No. | Frequency (MHz) | Reading (dBuV) | Correct (dB) | Result (dBuV) | Limit (dBuV) | Over (dB) | Detector |
|-----|-----------------|----------------|--------------|---------------|--------------|-----------|----------|
| 1 | 0.2060 | 12.17 | 10.12 | 22.29 | 53.37 | -31.08 | AVG |
| 2 | 0.2380 | 22.56 | 10.15 | 32.71 | 62.17 | -29.46 | QP |
| 3 | 0.6020 | 20.84 | 10.35 | 31.19 | 56.00 | -24.81 | QP |
| 4* | 0.7780 | 12.66 | 10.42 | 23.08 | 46.00 | -22.92 | AVG |
| 5 | 1.1540 | 8.69 | 10.52 | 19.21 | 46.00 | -26.79 | AVG |
| 6 | 1.4740 | 19.42 | 10.56 | 29.98 | 56.00 | -26.02 | QP |

Model C37-5.5-27/G12F/112 test data

| | | | |
|----------------------|------------------------|---------------|--------------|
| Job No.: | CE | Phase: | L1 |
| Standard: | EN55015 Conduction(QP) | Power Source: | AC 230V/50Hz |
| Test item: | Conduction Test | Date: | 2018/10/18 |
| Temp.(°C)/Hum.(%RH): | 23.5°C/55%RH | Time: | 15:08:02 |
| Note: | | | |

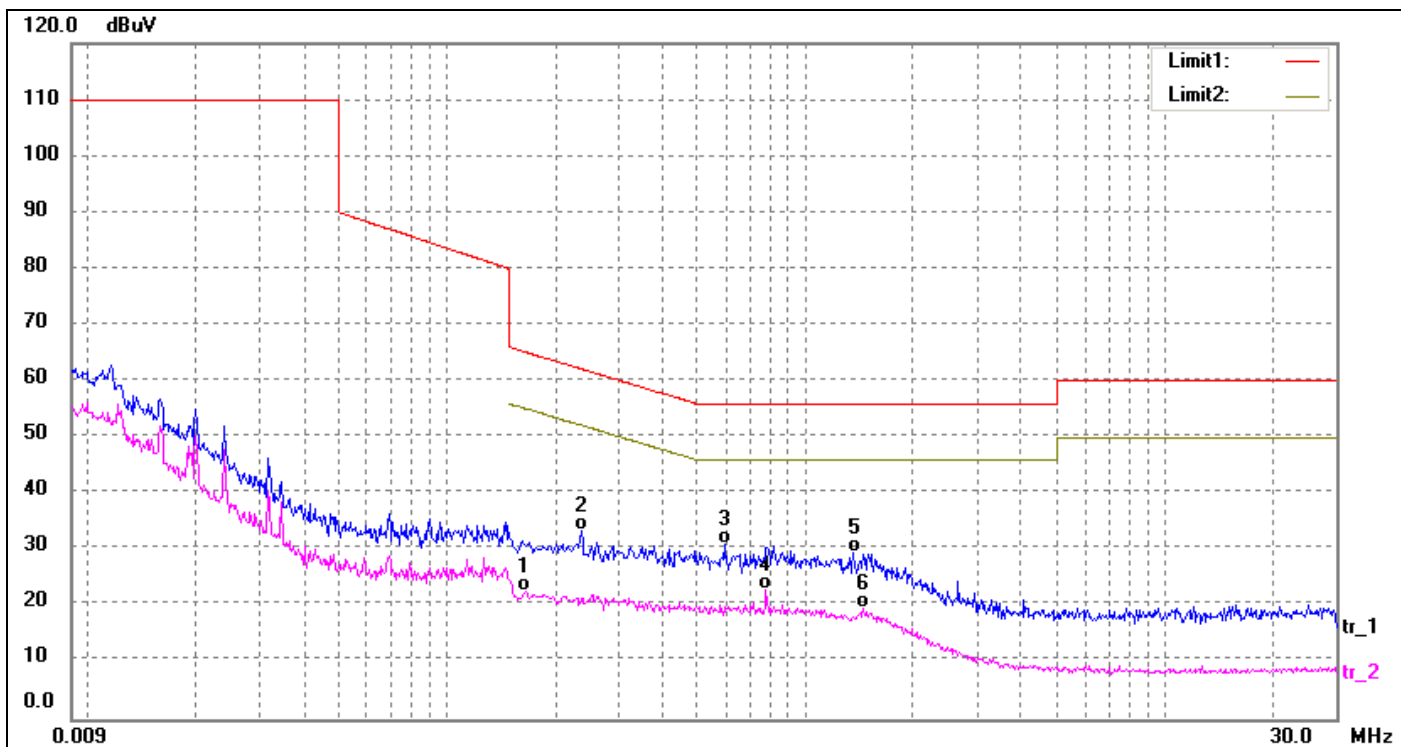

| No. | Frequency (MHz) | Reading (dBuV) | Correct (dB) | Result (dBuV) | Limit (dBuV) | Over (dB) | Detector |
|-----|-----------------|----------------|--------------|---------------|--------------|-----------|----------|
| 1 | 0.1660 | 12.40 | 10.11 | 22.51 | 55.16 | -32.65 | AVG |
| 2 | 0.2380 | 23.34 | 10.15 | 33.49 | 62.17 | -28.68 | QP |
| 3 | 0.5940 | 20.72 | 10.34 | 31.06 | 56.00 | -24.94 | QP |
| 4* | 0.7780 | 12.63 | 10.42 | 23.05 | 46.00 | -22.95 | AVG |
| 5 | 1.3540 | 18.93 | 10.54 | 29.47 | 56.00 | -26.53 | QP |
| 6 | 1.4460 | 8.96 | 10.55 | 19.51 | 46.00 | -26.49 | AVG |

Test Report No.: EFSH18100030-IE-01-E01

Eurofins Product Testing Service (Shanghai) Co., Ltd
 No. 395 West Jiangchang Road, Jing'an District, Shanghai, 200436, P.R. China

| | | | |
|-----------------------------|------------------------|----------------------|--------------|
| Job No.: | CE | Phase: | N |
| Standard: | EN55015 Conduction(QP) | Power Source: | AC 230V/50Hz |
| Test item: | Conduction Test | Date: | 2018/10/18 |
| Temp.(°C)/Hum.(%RH): | 23.5°C/55%RH | Time: | 15:02:14 |
| Note: | | | |

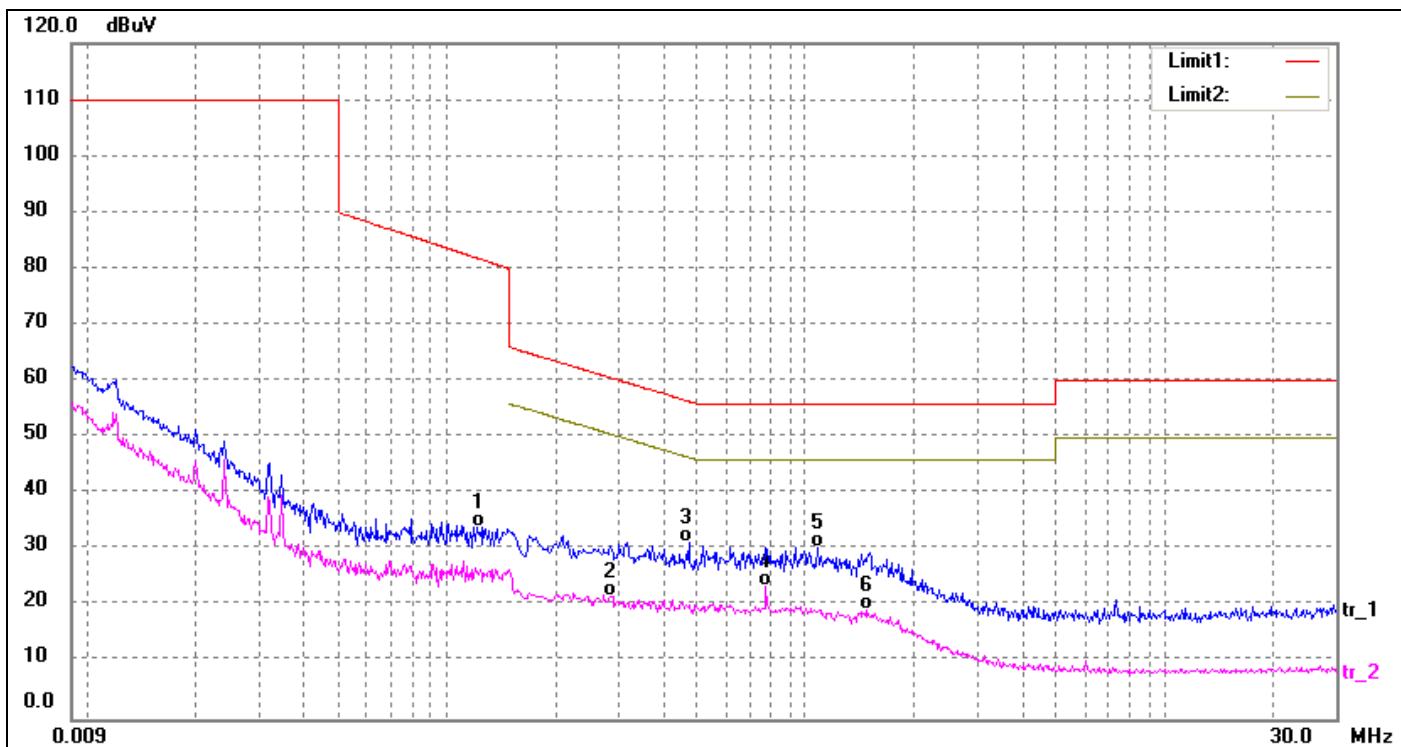

| No. | Frequency (MHz) | Reading (dBuV) | Correct (dB) | Result (dBuV) | Limit (dBuV) | Over (dB) | Detector |
|-----|-----------------|----------------|--------------|---------------|--------------|-----------|----------|
| 1 | 0.1253 | 23.84 | 10.10 | 33.94 | 81.64 | -47.70 | QP |
| 2 | 0.2860 | 11.52 | 10.18 | 21.70 | 50.64 | -28.94 | AVG |
| 3 | 0.4740 | 21.17 | 10.28 | 31.45 | 56.44 | -24.99 | QP |
| 4* | 0.7780 | 13.24 | 10.42 | 23.66 | 46.00 | -22.34 | AVG |
| 5 | 1.0860 | 20.03 | 10.51 | 30.54 | 56.00 | -25.46 | QP |
| 6 | 1.4820 | 8.80 | 10.56 | 19.36 | 46.00 | -26.64 | AVG |

4.2 Radiated electromagnetic disturbances

This clause lays down the general requirements for the magnetic component of the radiated disturbance field strength in the frequency range 9 kHz to 30 MHz

4.2.1 limits

| Frequency range Hz | Limits for loop diameter dB (μ A) |
|-----------------------|---|
| | 2 m |
| 9 kHz to 70 kHz | 88 |
| 70 kHz to 150 kHz | 88 to 58 |
| 150 kHz to 3 MHz | 58 to 22 |
| 3 MHz to 30 MHz | 22 |

Note: At the transition frequency, the lower limit applies.
Decreasing linearly with the logarithm of the frequency.
Increasing linearly with the logarithm of the frequency.

4.2.2 Measurement procedure

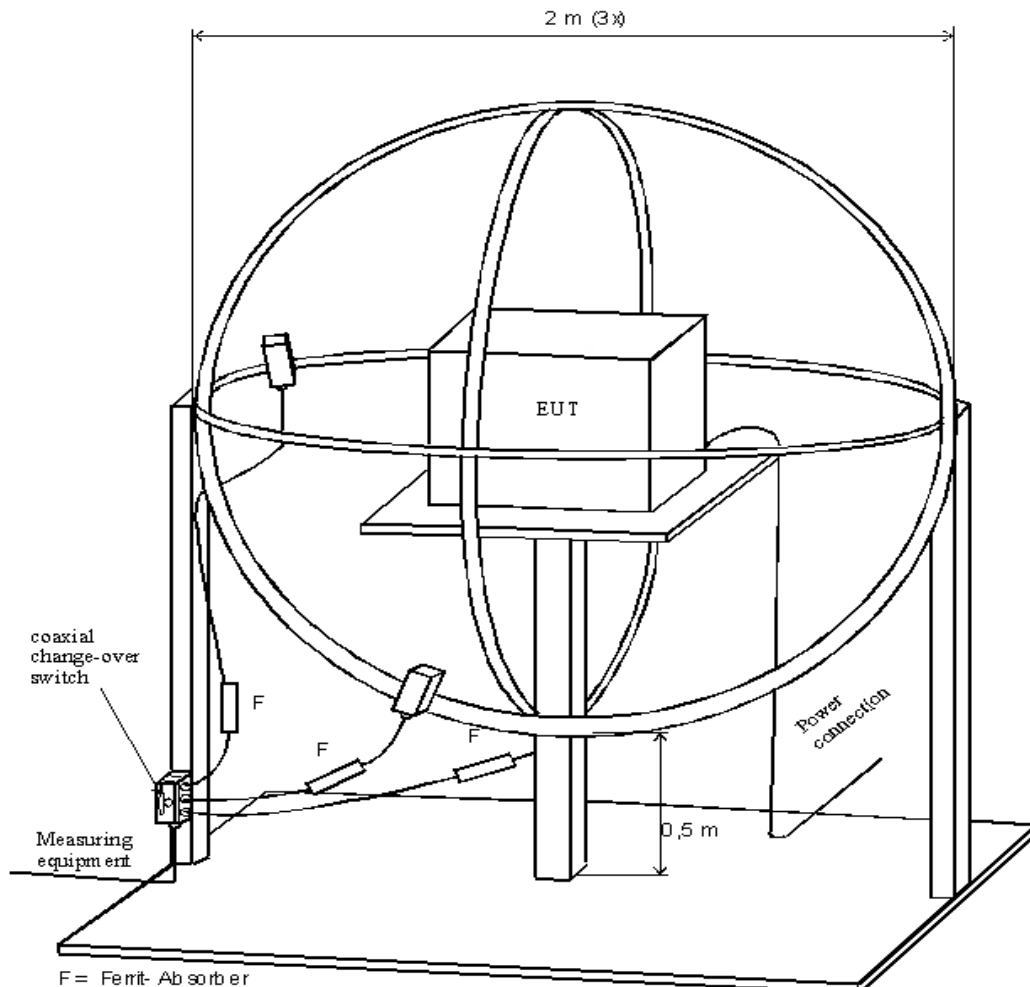

Test Report No.: EFSH18100030-IE-01-E01

Eurofins Product Testing Service (Shanghai) Co., Ltd
No. 395 West Jiangchang Road, Jing'an District, Shanghai, 200436, P.R. China

The EUT is placed in the centre of the loop antenna system. The current induced by the magnetic field from the EUT into each of the three large loop antennas of the loop antenna system is measured by connecting the current probe of the large loop antenna to a measuring receiver. During the measurements the EUT remains in a fixed position. Before get the final emission results with quasi-peak (QP) detector, a pre-scan was performed with the peak (PK) to find out the maximum emission data plots of the EUT.

4.2.3 Results

Model G45-5.5-27/G12F/112

| | | | |
|-----------------------------|---------------------|----------------------|--------------|
| Job No.: | 2018-CE | Phase: | X |
| Standard: | EN 55015 Three Loop | Power Source: | AC 230V/50Hz |
| Test item: | Conduction Test | Date: | 18/10/19/ |
| Temp.(°C)/Hum.(%RH): | 23.5°C/55%RH | Time: | 9/35/29 |
| Note: | | | |

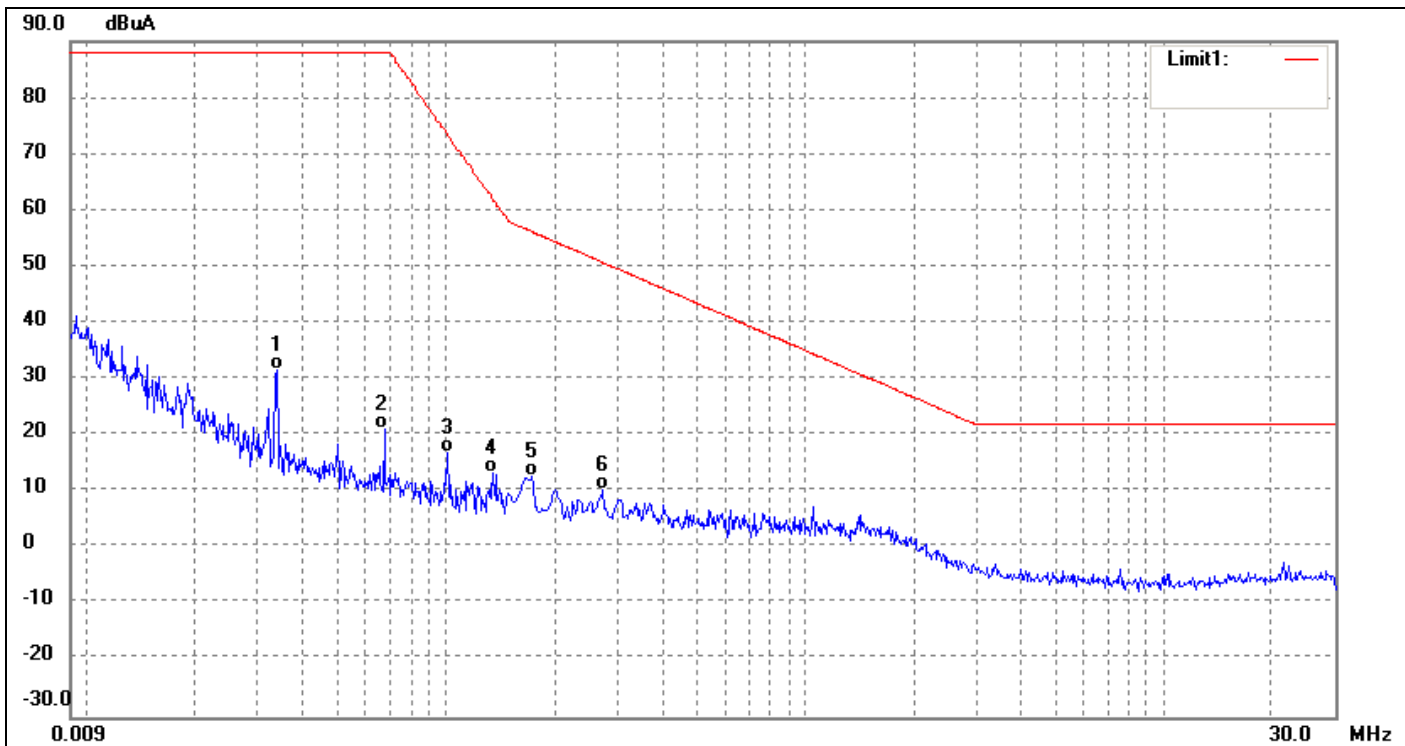

| No. | Frequency (MHz) | Reading (dBuA) | Correct (dB) | Result (dBuA) | Limit (dBuA) | Over (dB) | Detector |
|-----|-----------------|----------------|--------------|---------------|--------------|-----------|----------|
| 1 | 0.0339 | 4.26 | 27.49 | 31.75 | 88.00 | -56.25 | QP |
| 2 | 0.0677 | -1.46 | 22.71 | 21.25 | 88.00 | -66.75 | QP |
| 3 | 0.1016 | -4.56 | 21.55 | 16.99 | 73.34 | -56.35 | QP |
| 4 | 0.1354 | -7.81 | 21.24 | 13.43 | 62.03 | -48.60 | QP |
| 5 | 0.1740 | -8.13 | 20.89 | 12.76 | 56.22 | -43.46 | QP |
| 6* | 0.2740 | -10.18 | 20.55 | 10.37 | 50.76 | -40.39 | QP |

| | | | |
|-----------------------------|---------------------|----------------------|--------------|
| Job No.: | 2018-CE | Phase: | Y |
| Standard: | EN 55015 Three Loop | Power Source: | AC 230V/50Hz |
| Test item: | Conduction Test | Date: | 18/10/19/ |
| Temp.(°C)/Hum.(%RH): | 23.5°C/55%RH | Time: | 9/51/51 |
| Note: | | | |

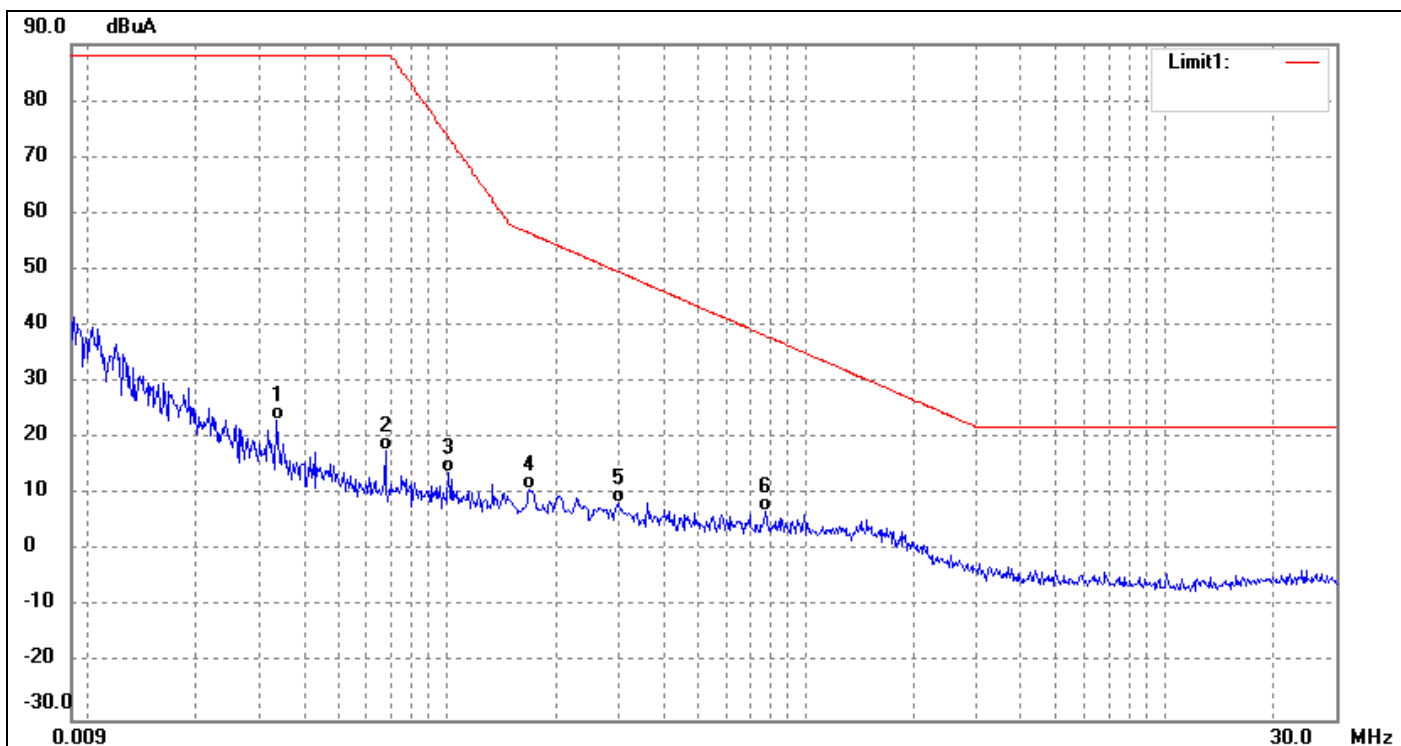

| No. | Frequency (MHz) | Reading (dBuA) | Correct (dB) | Result (dBuA) | Limit (dBuA) | Over (dB) | Detector |
|-----|-----------------|----------------|--------------|---------------|--------------|-----------|----------|
| 1 | 0.0338 | -4.16 | 27.52 | 23.36 | 88.00 | -64.64 | QP |
| 2 | 0.0676 | -4.86 | 22.72 | 17.86 | 88.00 | -70.14 | QP |
| 3 | 0.1013 | -7.62 | 21.55 | 13.93 | 73.45 | -59.52 | QP |
| 4 | 0.1700 | -10.09 | 20.93 | 10.84 | 56.50 | -45.66 | QP |
| 5 | 0.3020 | -11.86 | 20.51 | 8.65 | 49.59 | -40.94 | QP |
| 6* | 0.7780 | -12.98 | 20.07 | 7.09 | 38.22 | -31.13 | QP |

| | | | |
|-----------------------------|---------------------|----------------------|--------------|
| Job No.: | 2018-CE | Phase: | Z |
| Standard: | EN 55015 Three Loop | Power Source: | AC 230V/50Hz |
| Test item: | Conduction Test | Date: | 18/10/19/ |
| Temp.(°C)/Hum.(%RH): | 23.5°C/55%RH | Time: | 10/01/56 |
| Note: | | | |

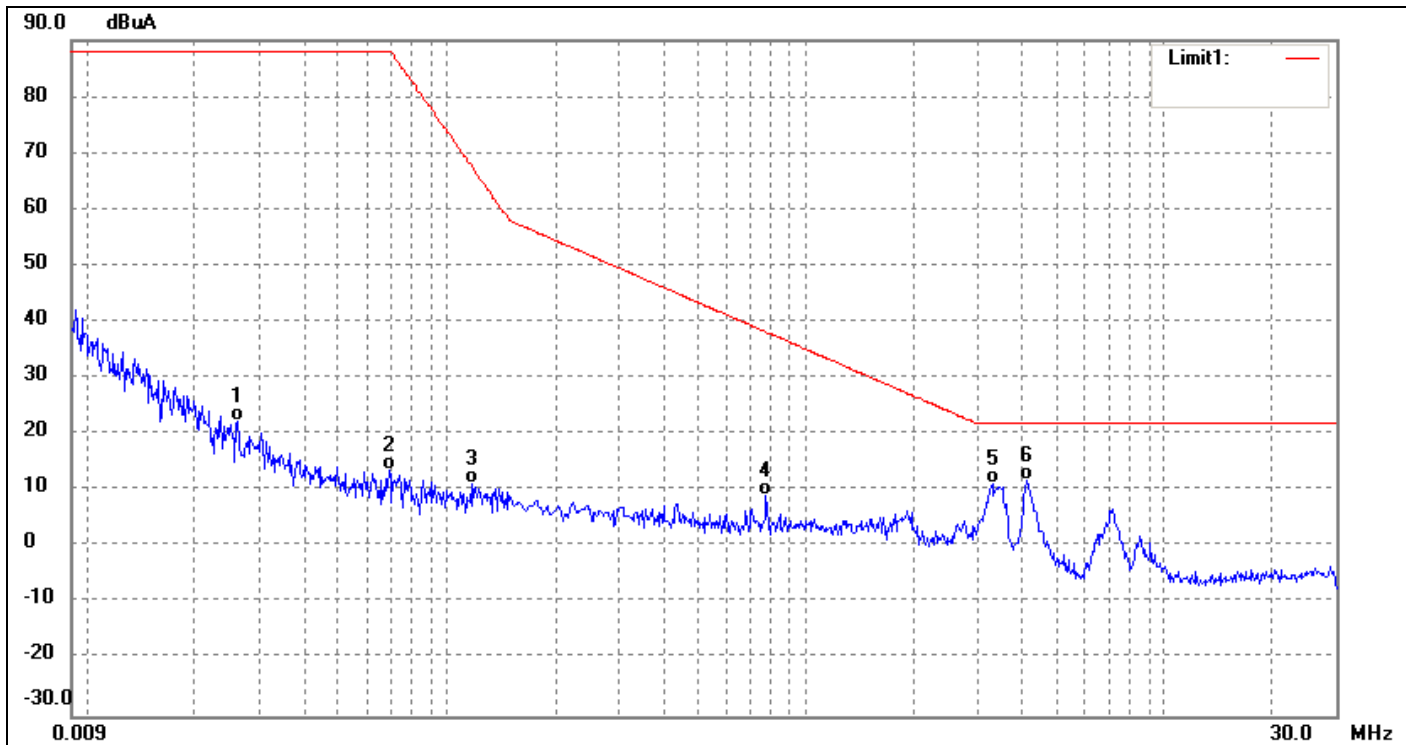

| No. | Frequency (MHz) | Reading (dBuA) | Correct (dB) | Result (dBuA) | Limit (dBuA) | Over (dB) | Detector |
|-----|--------------------|-------------------|-----------------|------------------|-----------------|--------------|----------|
| 1 | 0.0262 | -7.99 | 30.30 | 22.31 | 88.00 | -65.69 | QP |
| 2 | 0.0692 | -9.00 | 22.64 | 13.64 | 88.00 | -74.36 | QP |
| 3 | 0.1175 | -10.21 | 21.40 | 11.19 | 67.61 | -56.42 | QP |
| 4 | 0.7780 | -11.05 | 20.07 | 9.02 | 38.22 | -29.20 | QP |
| 5 | 3.3060 | -9.39 | 20.63 | 11.24 | 22.00 | -10.76 | QP |
| 6* | 4.1420 | -8.82 | 20.67 | 11.85 | 22.00 | -10.15 | QP |

Model C37-5.5-27/G12F/112 test data

| | | | |
|----------------------|---------------------|---------------|--------------|
| Job No.: | 2018-CE | Phase: | X |
| Standard: | EN 55015 Three Loop | Power Source: | AC 230V/50Hz |
| Test item: | Conduction Test | Date: | 18/10/19/ |
| Temp.(°C)/Hum.(%RH): | 23.5°C/55%RH | Time: | 9/41/28 |
| Note: | | | |

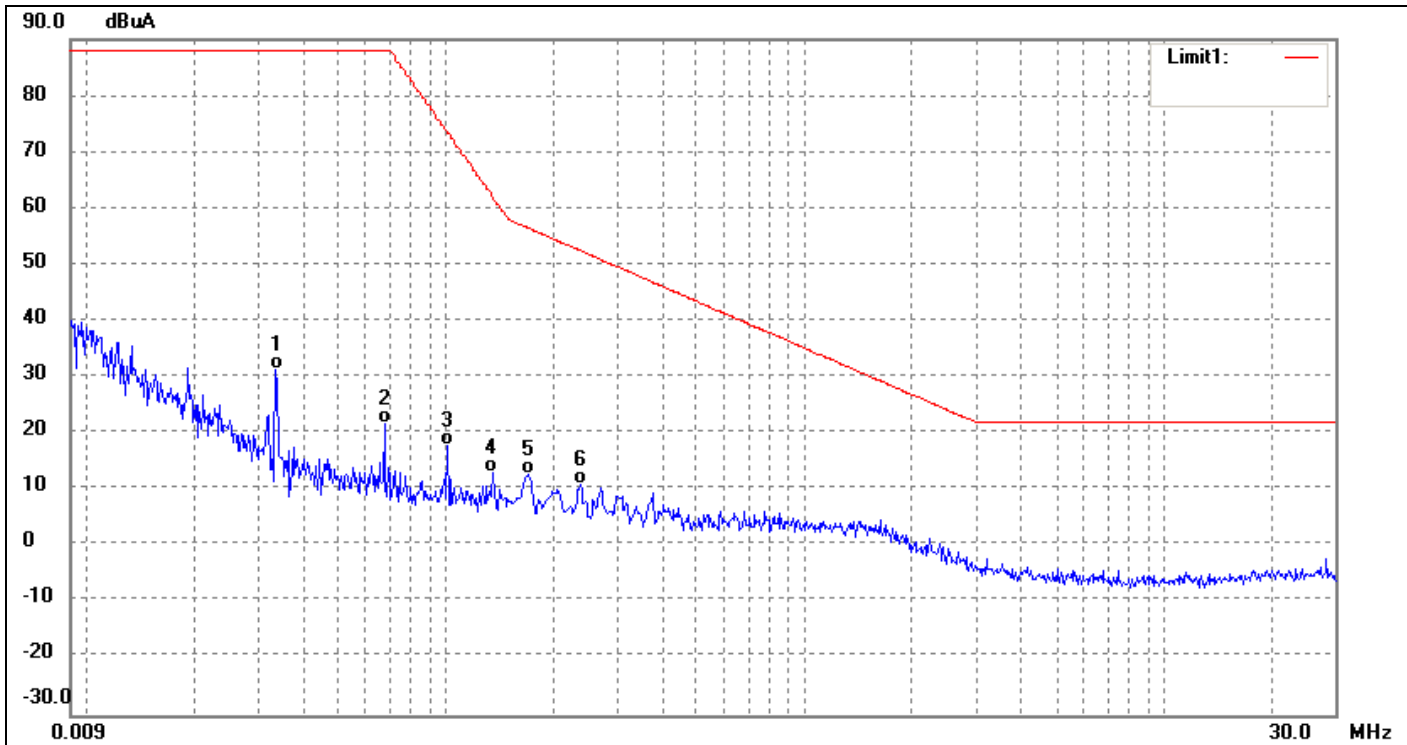

| No. | Frequency (MHz) | Reading (dBuA) | Correct (dB) | Result (dBuA) | Limit (dBuA) | Over (dB) | Detector |
|-----|-----------------|----------------|--------------|---------------|--------------|-----------|----------|
| 1 | 0.0338 | 3.97 | 27.52 | 31.49 | 88.00 | -56.51 | QP |
| 2 | 0.0676 | -0.94 | 22.72 | 21.78 | 88.00 | -66.22 | QP |
| 3 | 0.1015 | -3.57 | 21.55 | 17.98 | 73.37 | -55.39 | QP |
| 4 | 0.1353 | -8.06 | 21.24 | 13.18 | 62.06 | -48.88 | QP |
| 5 | 0.1700 | -8.15 | 20.93 | 12.78 | 56.50 | -43.72 | QP |
| 6* | 0.2380 | -9.75 | 20.60 | 10.85 | 52.45 | -41.60 | QP |

| | | | |
|-----------------------------|---------------------|----------------------|--------------|
| Job No.: | 2018-CE | Phase: | Y |
| Standard: | EN 55015 Three Loop | Power Source: | AC 230V/50Hz |
| Test item: | Conduction Test | Date: | 18/10/19/ |
| Temp.(°C)/Hum.(%RH): | 23.5°C/55%RH | Time: | 9/57/29 |
| Note: | | | |

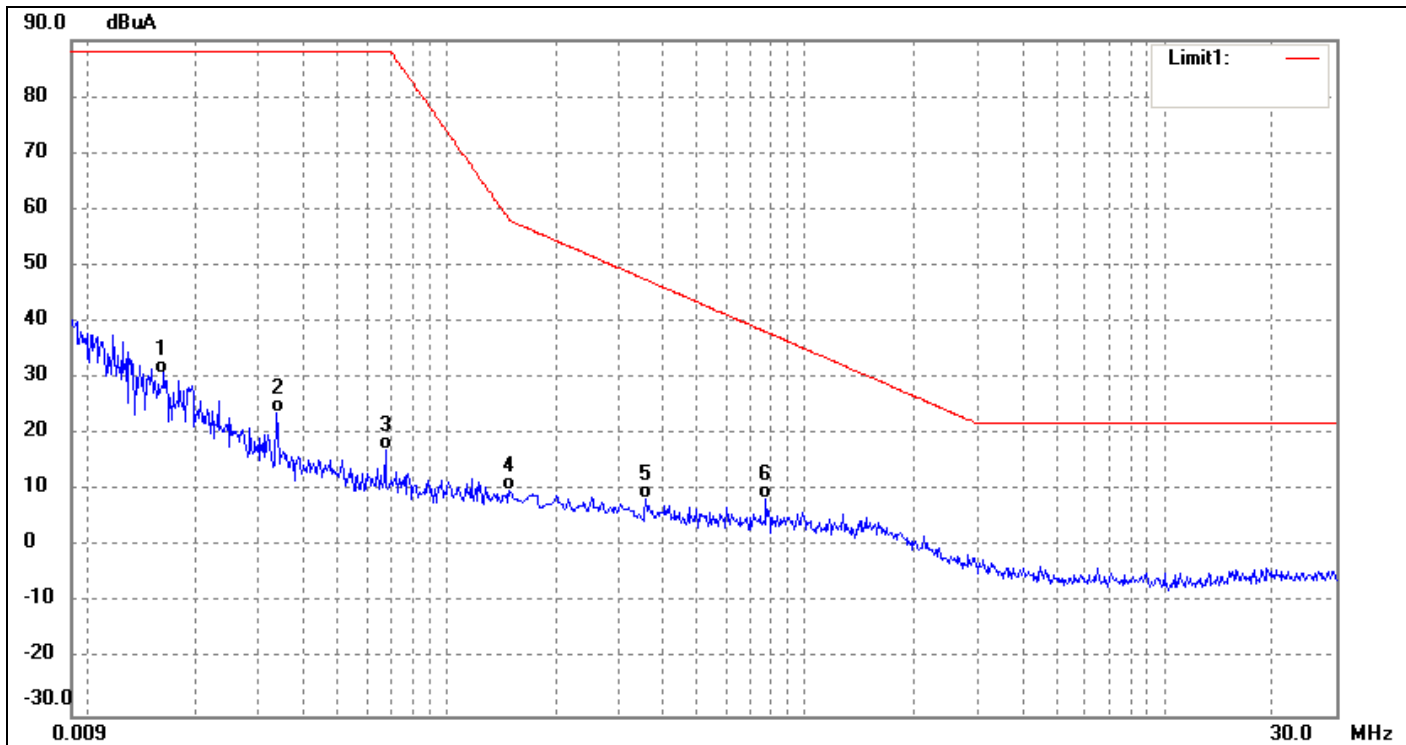

| No. | Frequency (MHz) | Reading (dBuA) | Correct (dB) | Result (dBuA) | Limit (dBuA) | Over (dB) | Detector |
|-----|--------------------|-------------------|-----------------|------------------|-----------------|--------------|----------|
| 1 | 0.0164 | -3.96 | 34.86 | 30.90 | 88.00 | -57.10 | QP |
| 2 | 0.0338 | -3.71 | 27.52 | 23.81 | 88.00 | -64.19 | QP |
| 3 | 0.0676 | -5.33 | 22.72 | 17.39 | 88.00 | -70.61 | QP |
| 4 | 0.1499 | -11.20 | 21.11 | 9.91 | 58.03 | -48.12 | QP |
| 5 | 0.3580 | -11.84 | 20.42 | 8.58 | 47.55 | -38.97 | QP |
| 6* | 0.7780 | -11.51 | 20.07 | 8.56 | 38.22 | -29.66 | QP |

| | | | |
|-----------------------------|---------------------|----------------------|--------------|
| Job No.: | 2018-CE | Phase: | Z |
| Standard: | EN 55015 Three Loop | Power Source: | AC 230V/50Hz |
| Test item: | Conduction Test | Date: | 18/10/19/ |
| Temp.(°C)/Hum.(%RH): | 23.5°C/55%RH | Time: | 10/06/30 |
| Note: | | | |

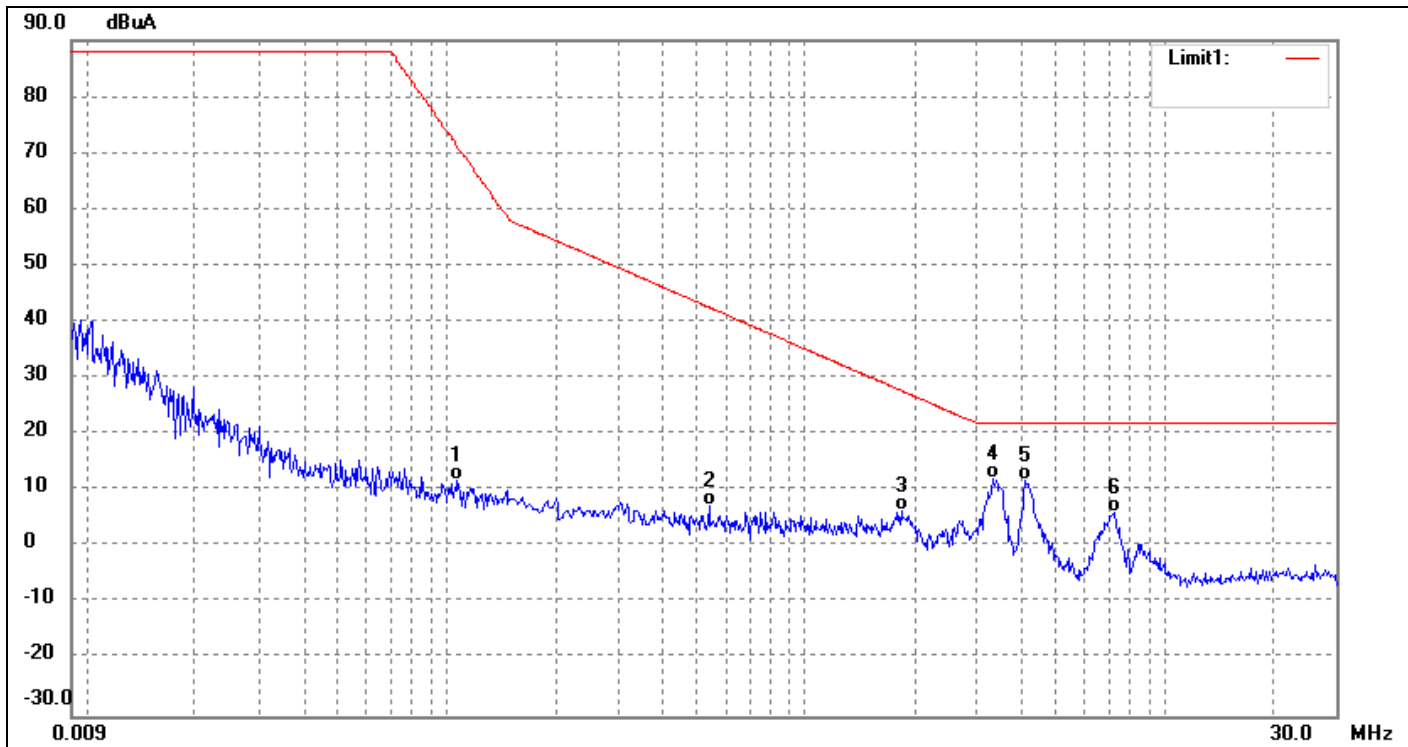

| No. | Frequency (MHz) | Reading (dBuA) | Correct (dB) | Result (dBuA) | Limit (dBuA) | Over (dB) | Detector |
|-----|-----------------|----------------|--------------|---------------|--------------|-----------|----------|
| 1 | 0.1071 | -9.73 | 21.50 | 11.77 | 71.26 | -59.49 | QP |
| 2 | 0.5380 | -12.85 | 20.22 | 7.37 | 42.65 | -35.28 | QP |
| 3 | 1.8540 | -14.15 | 20.49 | 6.34 | 27.78 | -21.44 | QP |
| 4* | 3.3260 | -8.62 | 20.63 | 12.01 | 22.00 | -9.99 | QP |
| 5 | 4.0860 | -8.74 | 20.66 | 11.92 | 22.00 | -10.08 | QP |
| 6 | 7.2260 | -14.35 | 20.51 | 6.16 | 22.00 | -15.84 | QP |

4.3 Radiated disturbance

This clause lays down the general requirements for the measurement of Radiated disturbance produced at the space of apparatus.

4.3.1 Limits

| Frequency range | Quasi-peak limits at 10m | Quasi-peak limits at 3m |
|-----------------|-------------------------------|-------------------------------|
| MHz | dB ($\mu\text{V}/\text{m}$) | dB ($\mu\text{V}/\text{m}$) |
| 30 to 230 | 30 | 40 |
| 230 to 300 | 37 | 47 |

At transitional frequencies the lower limit applies.

4.3.2 Measurement procedure

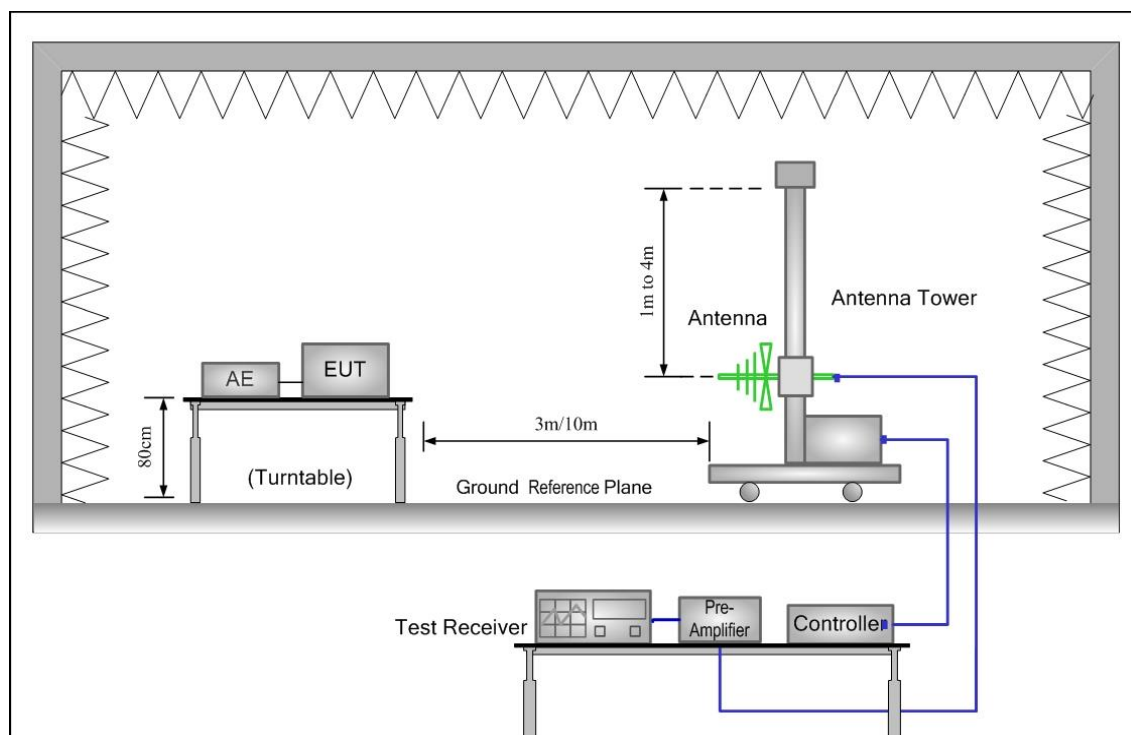

1. The radiated emissions test was conducted in a semi-anechoic chamber. The EUT was placed upon a non-metallic table 0.8m above the ground reference plane. And for floor-standing arrangement, the EUT was placed on the horizontal ground reference plane, but separated from metallic contact with the ground reference plane by 0.1m of insulation.
2. Before get the final emission results with quasi-peak(QP) detector, a pre-scan was performed with the peak(PK) detector to find out the maximum emission data plots of the EUT.
3. The frequencies of maximum emission were determined in the final radiated emissions measurement, the physical arrangement of the test system and associated cabling was varied in order to determine the effect on the EUT's emissions in amplitude, direction and frequency. At each frequency, the EUT was rotated 360°, and the antenna was raised and lowered from 1 to 4 meters in order to determine the maximum disturbance. Measurements were performed for both horizontal and vertical antenna polarization. Test was performed on subcontractor at 3 m distance.

4.3.3 Measurement uncertainty

U_{lab}(cond) = 3.9dB at 95% level of confidence, k=2

4.3.4 Results

Model G45-5.5-27/G12F/112

| | | | |
|---------------------|----------------|---------------|--------------|
| Job No.: | RE | Polarization: | Horizontal |
| Standard: | EN55015 | Power Source: | AC 230V/50Hz |
| Test item: | Radiation Test | Date: | 2018-10-18 |
| Temp.(C)/Hum.(%RH): | 22(C)/54%RH | Time: | 15:32:35 |
| Note: | | | |

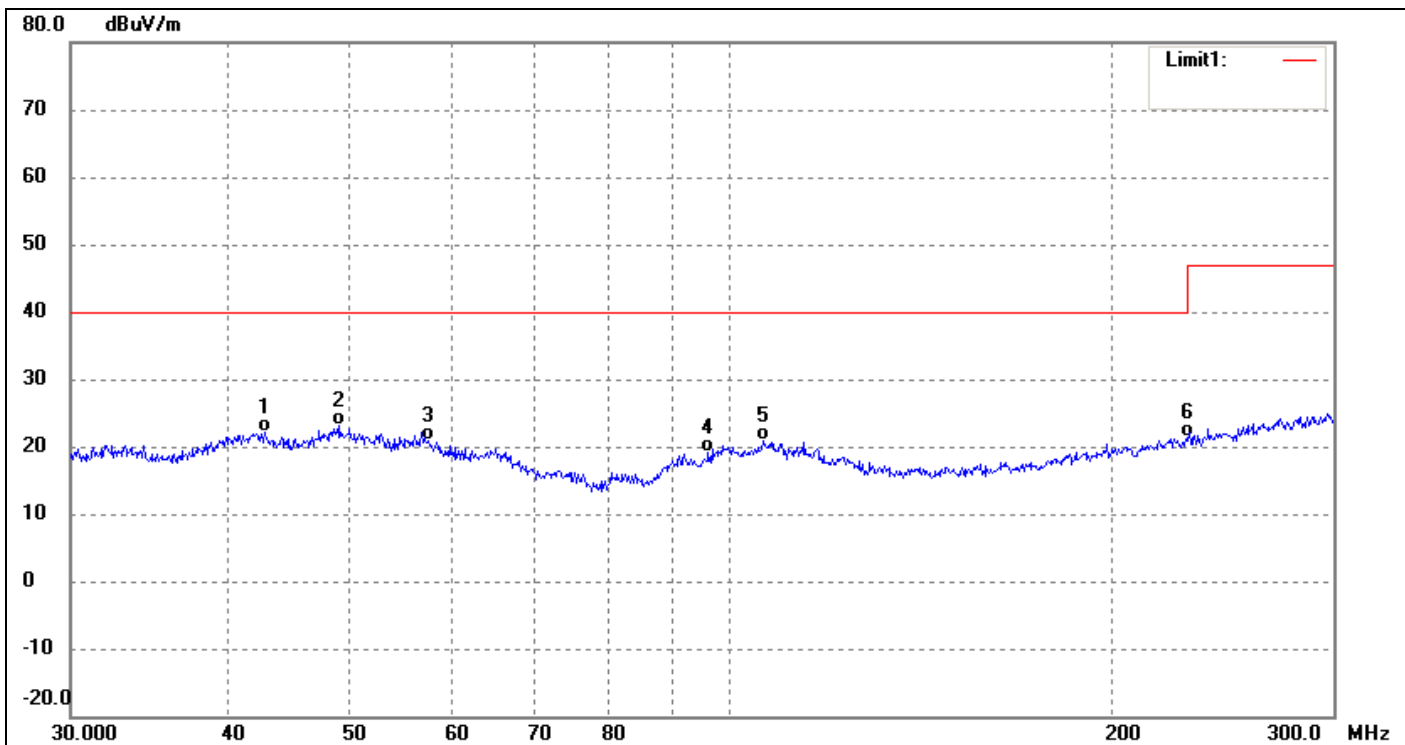

| No. | Frequency (MHz) | Reading (dBuV) | Correct dB/m | Result (dBuV/m) | Limit (dBuV/m) | Over (dB) | Remark |
|-----|-----------------|----------------|--------------|-----------------|----------------|-----------|--------|
| 1 | 42.7682 | 35.24 | -13.19 | 22.05 | 40.00 | -17.95 | QP |
| 2 | 48.9916 | 36.08 | -12.85 | 23.23 | 40.00 | -16.77 | QP |
| 3 | 57.5601 | 34.96 | -14.04 | 20.92 | 40.00 | -19.08 | QP |
| 4 | 95.9669 | 34.09 | -15.06 | 19.03 | 40.00 | -20.97 | QP |
| 5 | 106.1992 | 34.86 | -14.01 | 20.85 | 40.00 | -19.15 | QP |
| 6 | 229.6790 | 32.10 | -10.80 | 21.30 | 40.00 | -18.70 | QP |

Test Report No.: EFSH18100030-IE-01-E01

Eurofins Product Testing Service (Shanghai) Co., Ltd
No. 395 West Jiangchang Road, Jing'an District, Shanghai, 200436, P.R. China

| | | | |
|----------------------------|----------------|----------------------|--------------|
| Job No.: | RE | Polarization: | Vertical |
| Standard: | EN55015 | Power Source: | AC 230V/50Hz |
| Test item: | Radiation Test | Date: | 2018-10-18 |
| Temp.(C)/Hum.(%RH): | 22(C)/54%RH | Time: | 15:59:42 |
| Note: | | | |

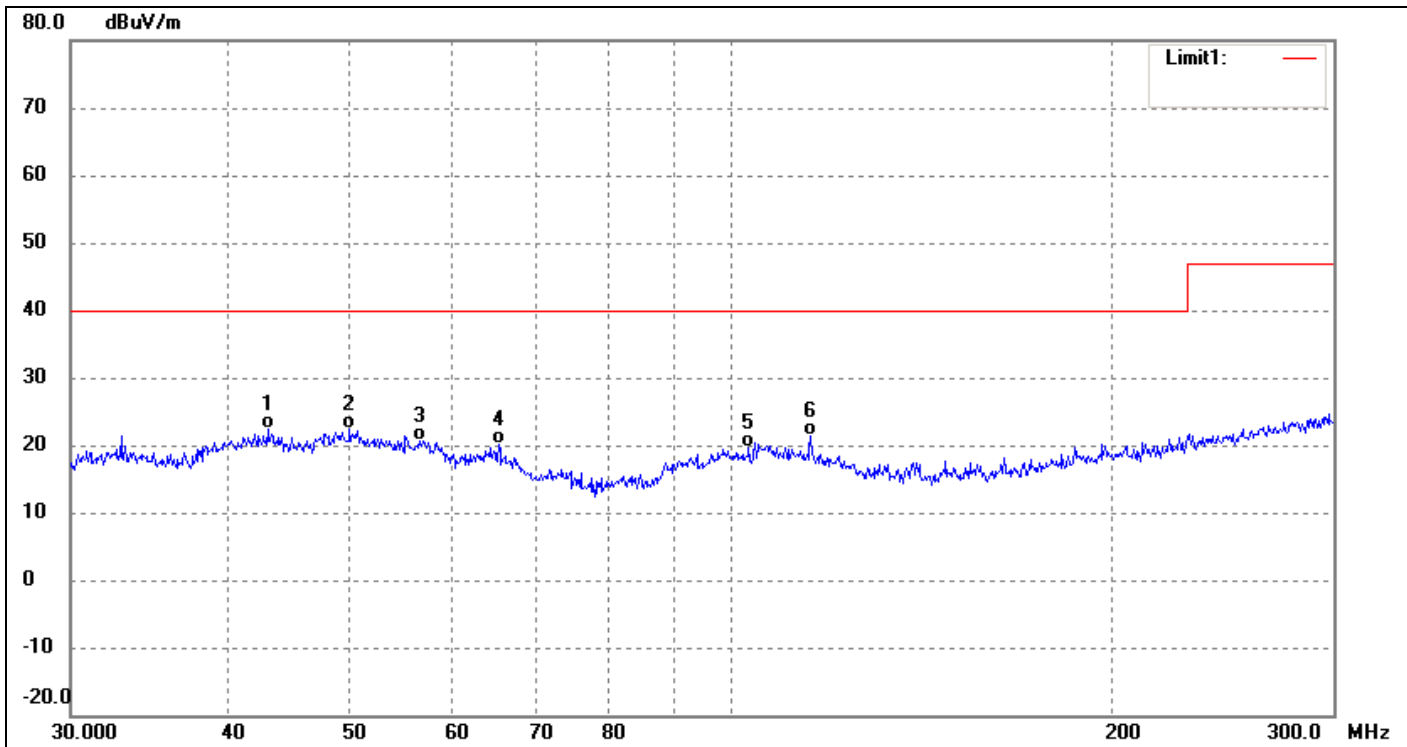

| No. | Frequency (MHz) | Reading (dBuV) | Correct dB/m | Result (dBuV/m) | Limit (dBuV/m) | Over (dB) | Remark |
|-----|-----------------|----------------|--------------|-----------------|----------------|-----------|--------|
| 1 | 42.9656 | 35.61 | -13.17 | 22.44 | 40.00 | -17.56 | QP |
| 2 | 49.9024 | 35.24 | -12.92 | 22.32 | 40.00 | -17.68 | QP |
| 3 | 56.6397 | 34.29 | -13.70 | 20.59 | 40.00 | -19.41 | QP |
| 4 | 65.4819 | 35.43 | -15.42 | 20.01 | 40.00 | -19.99 | QP |
| 5 | 103.3050 | 33.80 | -14.19 | 19.61 | 40.00 | -20.39 | QP |
| 6 | 115.6435 | 36.25 | -14.87 | 21.38 | 40.00 | -18.62 | QP |

Model C37-5.5-27/G12F/112 test data

| | | | |
|---------------------|----------------|---------------|--------------|
| Job No.: | RE | Polarization: | Horizontal |
| Standard: | EN55015 | Power Source: | AC 230V/50Hz |
| Test item: | Radiation Test | Date: | 2018-10-18 |
| Temp.(C)/Hum.(%RH): | 22(C)/54%RH | Time: | 16:04:42 |
| Note: | | | |

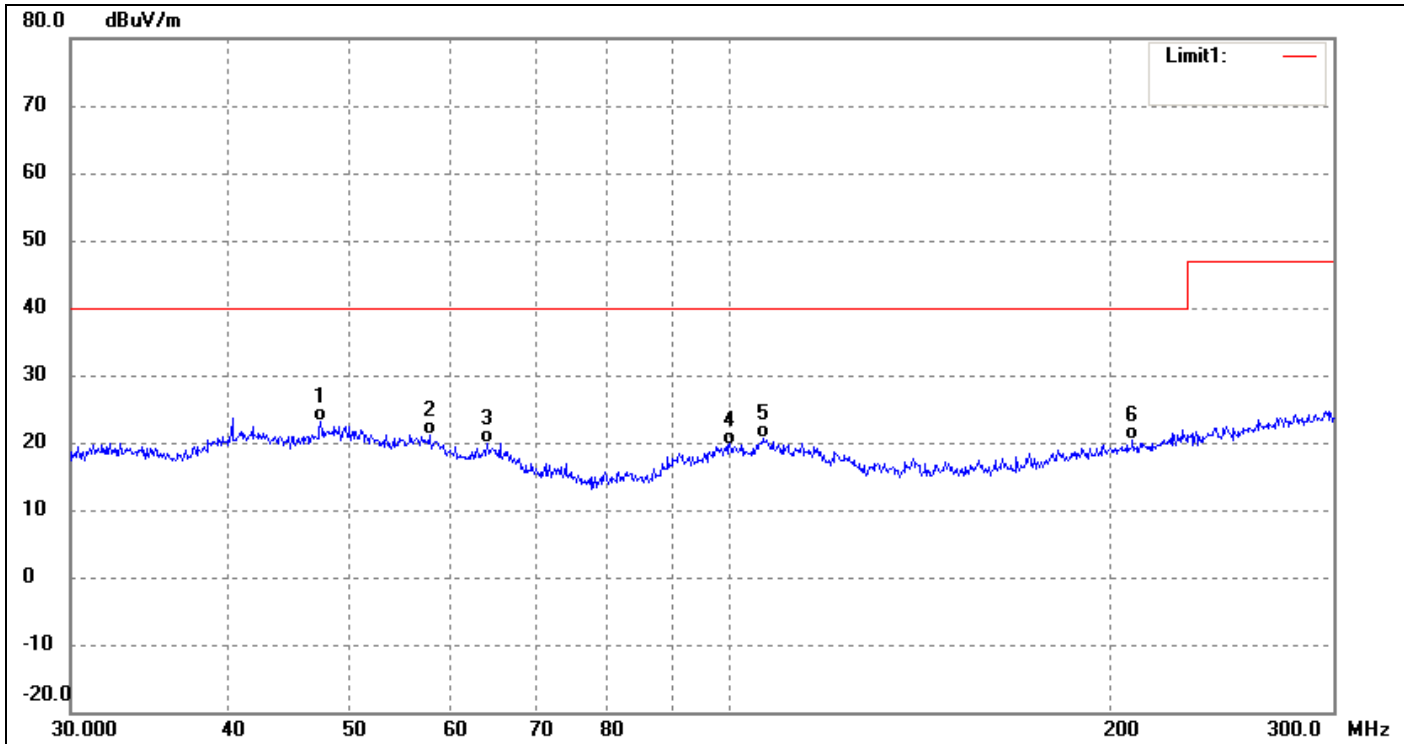

| No. | Frequency (MHz) | Reading (dBuV) | Correct (dB/m) | Result (dBuV/m) | Limit (dBuV/m) | Over (dB) | Remark |
|-----|-----------------|----------------|----------------|-----------------|----------------|-----------|--------|
| 1 | 47.3283 | 35.92 | -12.82 | 23.10 | 40.00 | -16.90 | QP |
| 2 | 57.6928 | 35.24 | -14.10 | 21.14 | 40.00 | -18.86 | QP |
| 3 | 64.1389 | 35.00 | -15.12 | 19.88 | 40.00 | -20.12 | QP |
| 4 | 99.7979 | 34.24 | -14.49 | 19.75 | 40.00 | -20.25 | QP |
| 5 | 105.9550 | 34.72 | -14.02 | 20.70 | 40.00 | -19.30 | QP |
| 6 | 208.0277 | 32.64 | -12.20 | 20.44 | 40.00 | -19.56 | QP |

Test Report No.: EFSH18100030-IE-01-E01

Eurofins Product Testing Service (Shanghai) Co., Ltd
 No. 395 West Jiangchang Road, Jing'an District, Shanghai, 200436, P.R. China

| | | | |
|----------------------------|----------------|----------------------|--------------|
| Job No.: | RE | Polarization: | Vertical |
| Standard: | EN55015 | Power Source: | AC 230V/50Hz |
| Test item: | Radiation Test | Date: | 2018-10-18 |
| Temp.(C)/Hum.(%RH): | 22(C)/54%RH | Time: | 16:07:59 |
| Note: | | | |

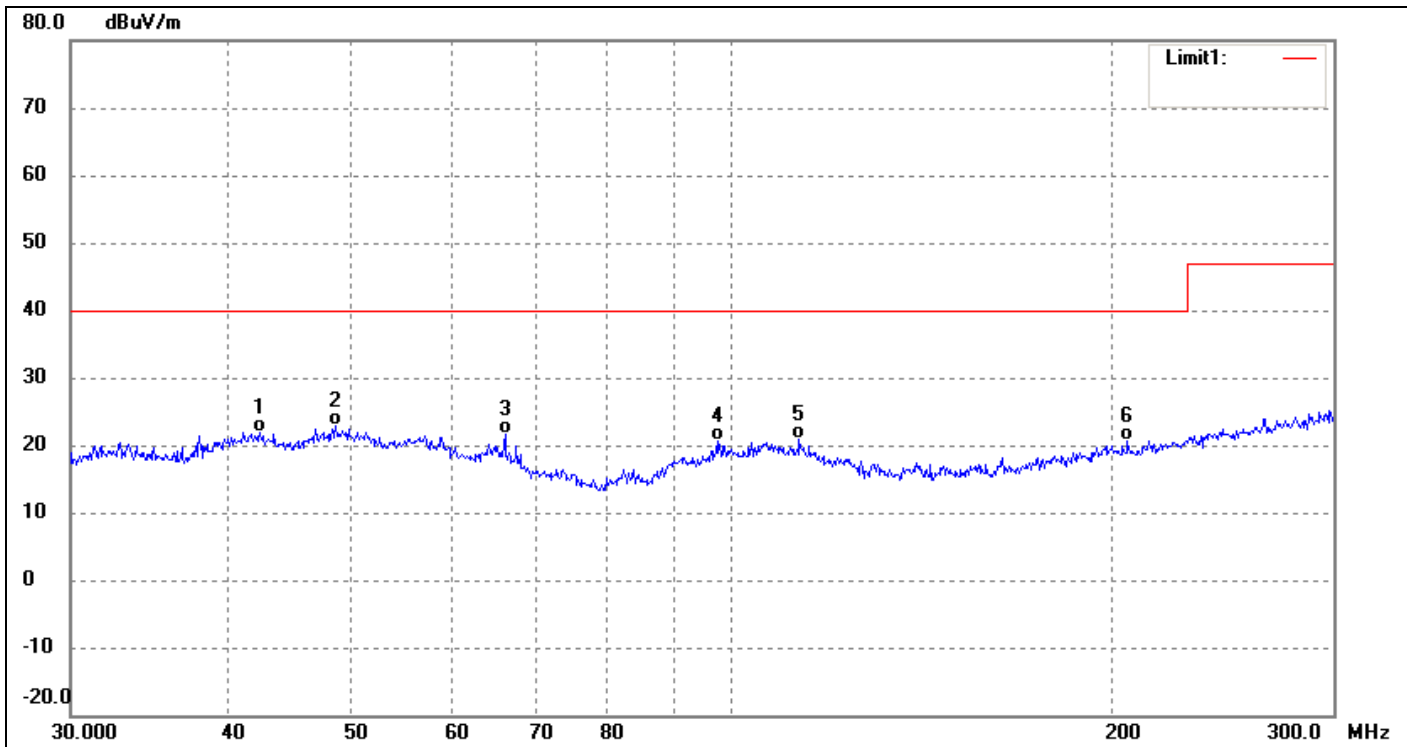

| No. | Frequency (MHz) | Reading (dBuV) | Correct (dB/m) | Result (dBuV/m) | Limit (dBuV/m) | Over (dB) | Remark |
|-----|-----------------|----------------|----------------|-----------------|----------------|-----------|--------|
| 1 | 42.3761 | 35.19 | -13.24 | 21.95 | 40.00 | -18.05 | QP |
| 2 | 48.6543 | 35.74 | -12.82 | 22.92 | 40.00 | -17.08 | QP |
| 3 | 66.2401 | 37.32 | -15.72 | 21.60 | 40.00 | -18.40 | QP |
| 4 | 97.5262 | 35.48 | -14.83 | 20.65 | 40.00 | -19.35 | QP |
| 5 | 113.2717 | 35.44 | -14.48 | 20.96 | 40.00 | -19.04 | QP |
| 6 | 206.1205 | 32.80 | -12.25 | 20.55 | 40.00 | -19.45 | QP |

4.4 Voltage Changes, Voltage Fluctuations and Flicker

This part is concerned with the limitation of voltage fluctuations and flicker impressed on the public low-voltage system.

4.4.1 Limits

| Value | Limit |
|-------|-------|
| Pst | 1,0 |
| Plt | 0,65 |
| dt | 3,3% |
| dc | 3,3% |
| dmax | 4,0% |

4.4.2 Measurement test procedure

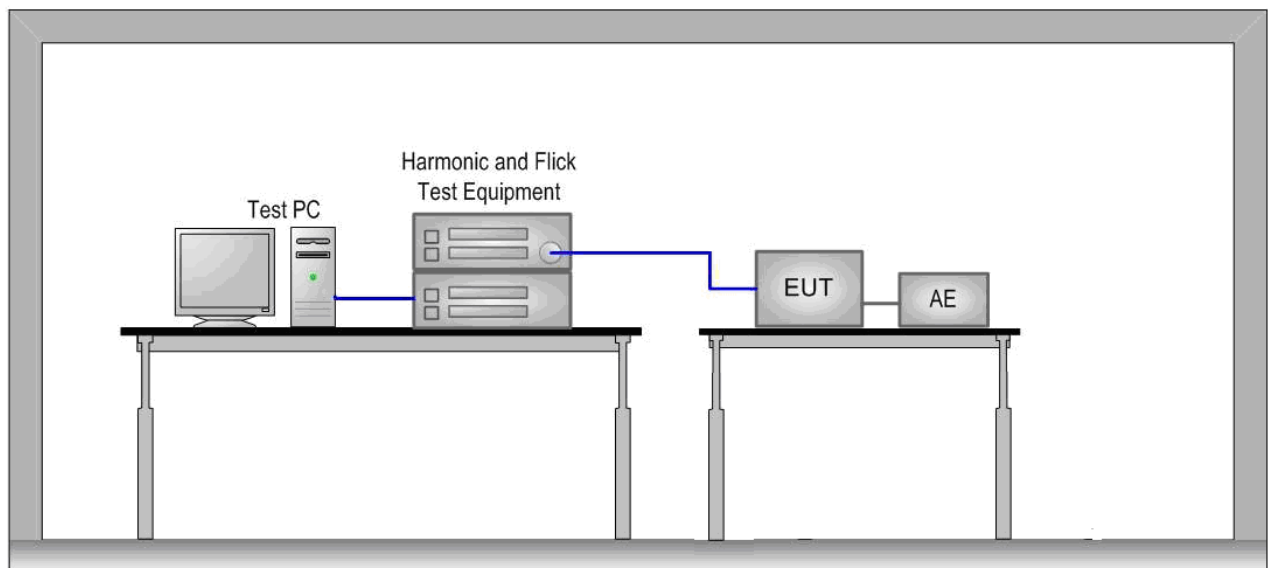

The equipment under test is placed on a wooden table with a height of 0,8 m in the EMC lab. The voltage changes, fluctuations and flicker were measured at the supply terminals of the EUT.

4.4.3 Results

Model G45-5.5-27/G12F/112

Parameter values recorded during the test:

| | | | | |
|---------------------------------|--------|------------------|-------|------|
| Vrms at the end of test (Volt): | 231.42 | | | |
| T-max (mS): | 0 | Test limit (mS): | 500.0 | Pass |
| Highest dc (%): | 0.00 | Test limit (%): | 3.30 | Pass |
| Highest dmax (%): | 0.00 | Test limit (%): | 4.00 | Pass |
| Highest Pst (10 min. period): | 0.064 | Test limit: | 1.000 | Pass |

Model C37-5.5-27/G12F/112 test data**Parameter values recorded during the test:**

| | | | | |
|--|---------------|-------------------------|--------------|-------------|
| Vrms at the end of test (Volt): | 229.88 | | | |
| T-max (mS): | 0 | Test limit (mS): | 500.0 | Pass |
| Highest dc (%): | 0.00 | Test limit (%): | 3.30 | Pass |
| Highest dmax (%): | 0.00 | Test limit (%): | 4.00 | Pass |
| Highest Pst (10 min. period): | 0.064 | Test limit: | 1.000 | Pass |

5 Immunity Test

5.1 Performance Criteria Description in Clause 4 of EN 61547

| | |
|---------------------|--|
| Criterion A: | During the test, no change of the luminous intensity shall be observed and the regulating control, if any, shall operate during the test as intended. |
| Criterion B: | During the test, the luminous intensity may change to any value. After the test, the luminous intensity shall be restored to its initial value within 1 min. Regulating controls need not function during the test, but after the test, the mode of the control shall be the same as before the test provided that during the test no mode changing commands were given. |
| Criterion C: | During and after the test, any change of the luminous intensity is allowed and the lamp(s) may be extinguished. After the test, within 30 min, all functions shall return to normal, if necessary by temporary interruption of the mains supply and/or operating the regulating control. Additional requirement for lighting equipment incorporating a starting device: After the test, the lighting equipment is switched off. After half an hour, it is switched on again. The lighting equipment shall start and operate as intended. |

5.2 Conditions during testing

The test shall be applied while the equipment is operated as intended under the normal operating conditions as laid down in the relevant product standard at stabilized luminous (radiant) flux and at normal laboratory conditions. Testing is only required at one combination of supply voltage and frequency, as specified by the manufacturer. Equipment including a regulating control shall be tested at a light output level of 50 % \pm 10 %. The lamp load of the equipment under test shall be the maximum allowed. Luminaires and independent auxiliaries shall be tested with lamps for which they are intended. Where equipment can operate with lamps of different wattages, lamps of maximum wattage shall be applied. For independent auxiliaries, the length of the cables between device and lamp shall be 3 m unless the manufacturer prescribes another length.

5.3 ESD

5.3.1 Test Procedures

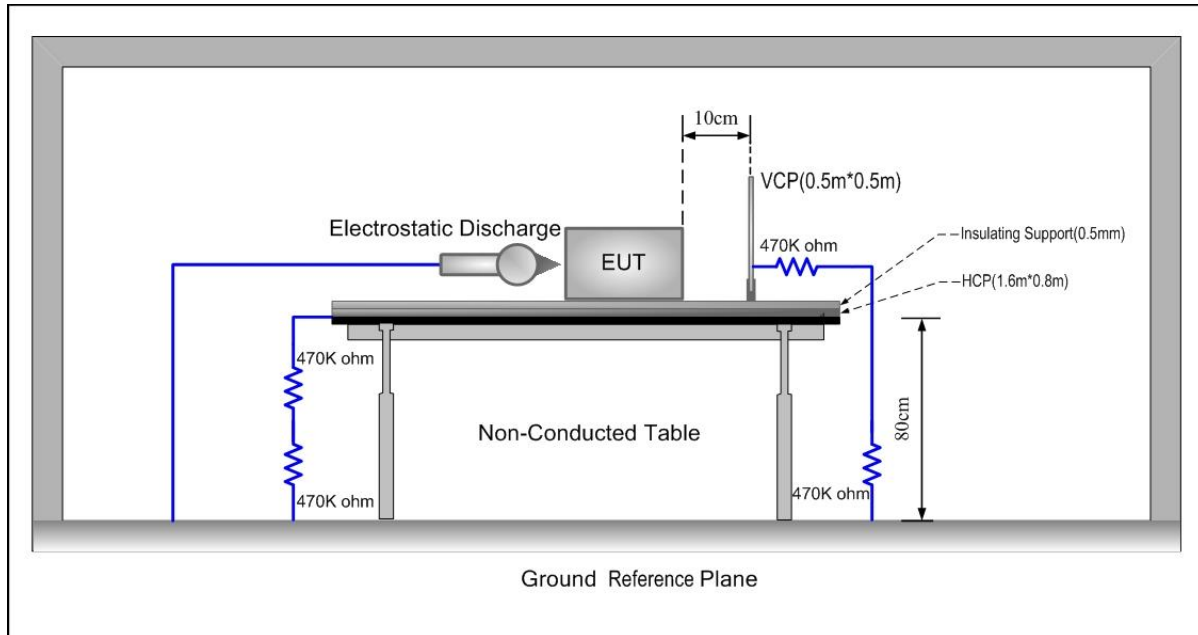

1. Contact discharge was applied only to conductive surfaces of the EUT. Air discharge was applied only to non-conducted surfaces of the EUT.
2. The EUT was put on a 0.8m high wooden table for table-top equipment or 0.1m high for floor standing equipment standing on the ground reference plane (GRP).
3. A horizontal coupling plane(HCP) 1.6m by 0.8m in size was placed on the table, and the EUT with its cables were isolated from the HCP by an insulating support thick than 0.5mm. The VCP 0.5m by 0.5m in size while HCP were constructed from the same material type and thickness as that of the GRP, and connected to the GRP via a 470kΩ resistor at each end. The distance between EUT and any of the other metallic surfaces excepted the GRP, HCP and VCP was greater than 1m.
4. During the contact discharges, the tip of the discharge electrode was touching the EUT before the discharge switch is operated. During the air discharges, the round discharge tip of the discharge electrode was approached as fast as possible to touch the EUT. After each discharge, the ESD generator was removed from the EUT, the generator is then retriggered for a new single discharge. For ungrounded product, a discharge cable with two resistances was used after each discharge to remove remnant electrostatic voltage. 10 times of each polarity single discharge were applied to HCP and VCP.

5.3.2 Results

Model G45-5.5-27/G12F/112, C37-5.5-27/G12F/112

| Test point | Table (T) Floor (F) | Contact (C) Air (A) | Voltage (kV) | Number of discharge | Polarity (+ / -) | Opinion |
|-------------------|------------------------|------------------------|-----------------|------------------------|---------------------|---------|
| Air discharge | T | A | ±2, ±4, ±8 | Mini 20/point | + / - | A |
| Contact discharge | T | C | ±2, ±4 | Mini 20/point | + / - | A |
| HCP | T | C | ±2, ±4 | Mini 20/point | + / - | A |
| VCP | T | C | ±2, ±4 | Mini 20/point | + / - | A |

A: no loss of function.

5.4 Radio frequency electromagnetic fields

5.4.1 Measurement procedure

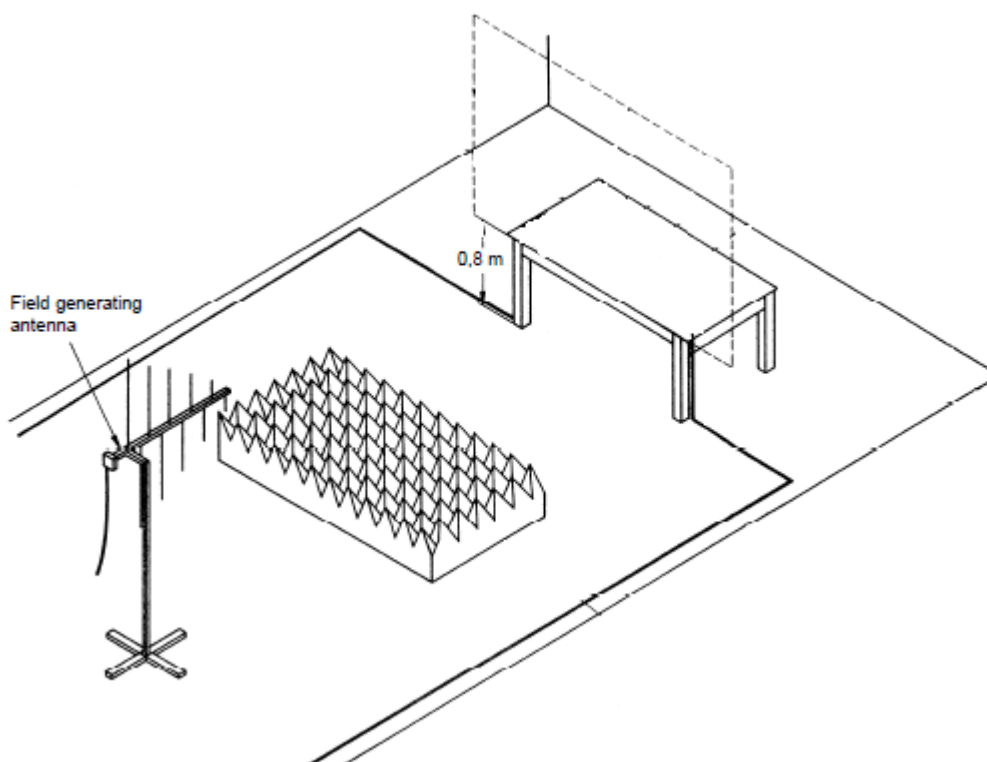

1. The EUT was placed on 0.8m high wooden table for table-top equipment. For floor standing equipment, the EUT was placed on a 0.1m high wooden support above the GRP. The tests normally shall be performed with the generating antenna facing each of four sides of the EUT. When equipment can be used in different orientations (e.g. vertical or horizontal) the test shall be performed on all possible sides of the EUT.
2. The tests are carried out with a field strength by 3 V/m (measured in the unmodulated field) with amplitude modulated signal by a depth of 80 % by a sinusoidal audio signal of 1 kHz. The logarithmic step was 1% and the dwell time was 3s dependent of the EUT cycle time. Test was performed on subcontractor.

5.4.2 Results

Model G45-5.5-27/G12F/112, C37-5.5-27/G12F/112

| Frequency Range | Field Strength | Modulation | Antenna Polarity | Opinion |
|-----------------|----------------|-------------|------------------|---------|
| 80MHz-1GHz | 3V/m | 80% AM 1kHz | Horizontal | A |
| 80MHz-1GHz | 3V/m | 80% AM 1kHz | Vertical | A |

A: no loss of function.

5.5 Electrical Fast Transients

5.5.1 Measurement procedure

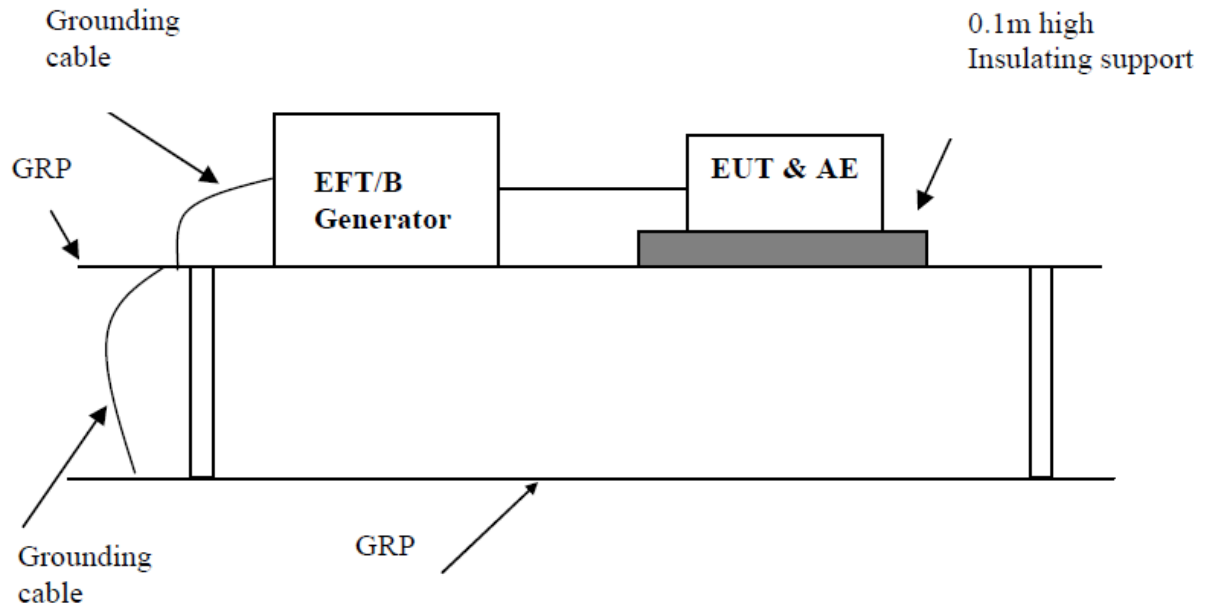

1. The EUT was placed on a ground reference plane (GRP) insulated by an insulating support 0.1 m thick and the GRP was placed on a 0.8m high wooden table for table-top equipment. For floor standing equipment, the EUT was placed on a 0.1m high wooden support above the GRP.
2. The GRP shall project beyond the EUT and the clamp by at least 0.1m on all sides. The distance between the EUT and any other of the metallic surface except the GRP was greater than 0.5m. All cables to the EUT were placed on the insulating support 0.1m above GRP. Cables not subject to EFT were routed as far as possible from cable under test to minimize the coupling between the cables.
3. The length of signal and power cable between the EUT and EFT generator was 0.5m. If the cable is a non-detachable supply cable more than 0.5m, the excess length of this cable shall be folded to avoid a flat coil and situated at a distance of 0.1m above the GRP.

5.5.2 Results

Model G45-5.5-27/G12F/112, C37-5.5-27/G12F/112

| Test port | Voltage (kV) | Polarity (+ / -) | Duration (s or min) | Waveform Tr / Th | Repetition Frequency (kHz) | Opinion |
|----------------|--------------|------------------|---------------------|------------------|----------------------------|---------|
| a.c. port, L | 1 | +/- | 2 min | 5/50 ns | 5 | A |
| a.c. port, N | 1 | +/- | 2 min | 5/50 ns | 5 | A |
| a.c. port, L+N | 1 | +/- | 2 min | 5/50 ns | 5 | A |

A: no loss of function.

5.6 Injected currents(RF continues conducted)

5.6.1 Measurement procedure

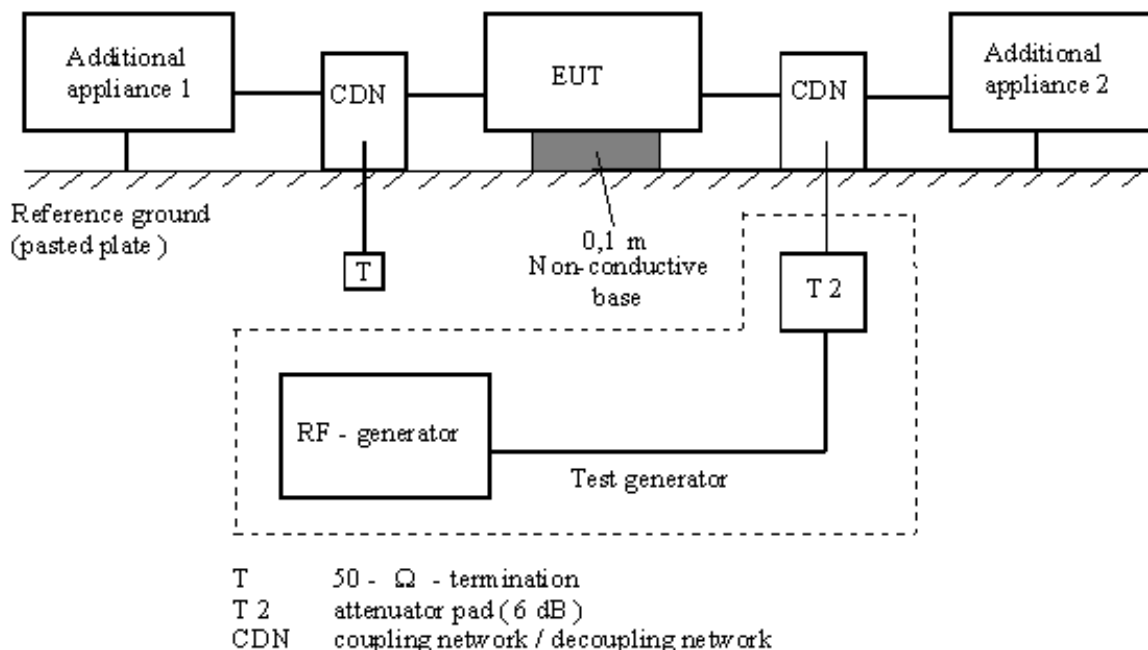

1. The EUT was placed on an insulating support of 0.1m height above a ground reference Plane, arranged and connected to satisfy its functional requirement. All cables exiting the EUT was supported at a height of at least 30 mm above the ground reference plane.
2. The coupling and decoupling devices were required, they were located between 0,1 m and 0,3 m from the EUT. This distance was to be measured horizontally from the projection of the EUT on to the ground reference plane to the coupling and decoupling device.
3. The frequency range was swept from 150 kHz to 80 MHz, using the signal levels established during the setting process, and with the disturbance signal 80 % amplitude modulated with a 1 kHz sine wave, pausing to adjust the RF signal level or to change coupling devices as necessary. Where the frequency was swept incrementally, the step size does not exceed 1 % of the preceding frequency value. The dwell time of the amplitude modulated carrier at each frequency was not less than the time necessary for the EUT to be exercised and to respond, and was not less than 3 s.

5.6.2 Results

Model G45-5.5-27/G12F/112, C37-5.5-27/G12F/112

| Test port | Voltage (e.m.f.) | Modulation | Frequency Range | Opinion |
|---------------|------------------|--------------|------------------|---------|
| AC power line | 3V | 80% AM 1 kHz | 150 kHz - 80 MHz | A |

A: no loss of function.

5.7 Surge Immunity

5.7.1 Measurement procedure

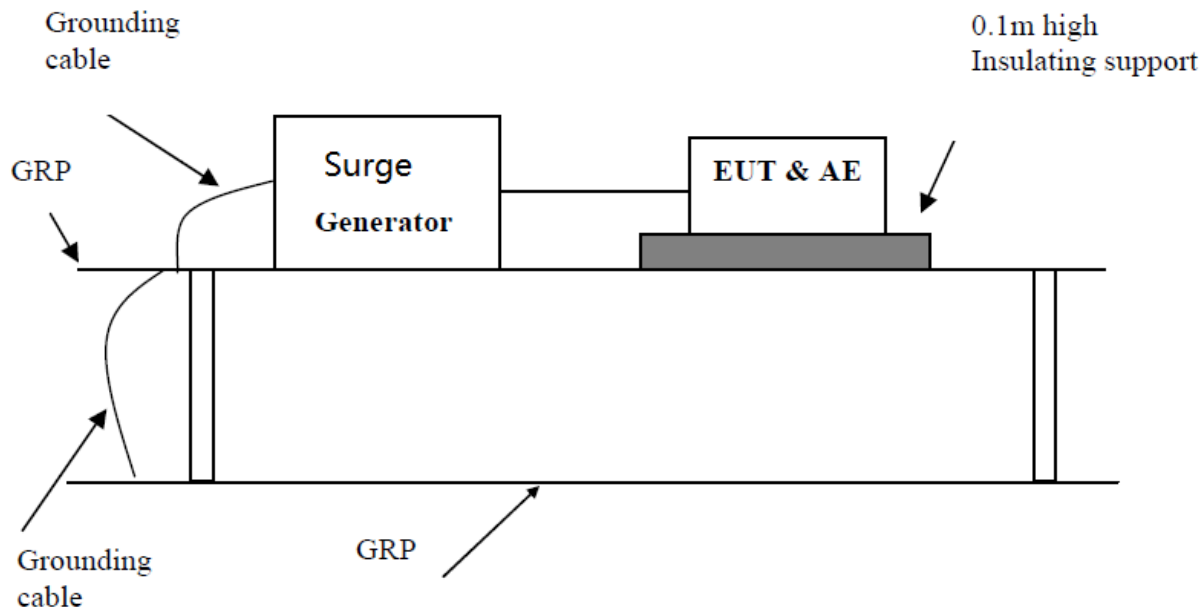

1. The EUT was placed on a ground reference plane (GRP) insulated by an insulating support 0.1 m thick and the GRP was placed on a 0.8m high wooden table for table-top equipment. For floor standing equipment, the EUT was placed on a 0.1m high wooden support above the GRP.
2. The 1.2/50 μ s surge was to be applied to the EUT power supply terminals via the capacitive coupling network. Decoupling networks were required in order to avoid possible adverse effects on equipment not under test that may be powered by the same lines and to provide sufficient decoupling impedance to the surge wave so that the specified wave may be applied on the lines under test.
3. Pulses shall be applied to the a.c. voltage wave as follows; five positive polarity pulses at the 90° phase angle, five negative polarity pulses at the 270° phase angle.

5.7.2 Results

Model G45-5.5-27/G12F/112, C37-5.5-27/G12F/112

| Test port | Polarity (+ / -) | Voltage (kV) | Voltage Waveform | Current Waveform | Repetition Rate | Number of pulses | Opinion |
|----------------|------------------|--------------|------------------|------------------|-----------------|------------------|---------|
| a.c. port, L-N | +/- | 0.5 | 1.2/50 μ s | 8/20 μ s | 1 per min | 5 /point | B |

A: no loss of function.

B: the appliance would not work normally during the test, but after test it would recover.

5.8 Voltage dips and Interruption

5.8.1 Measurement procedure

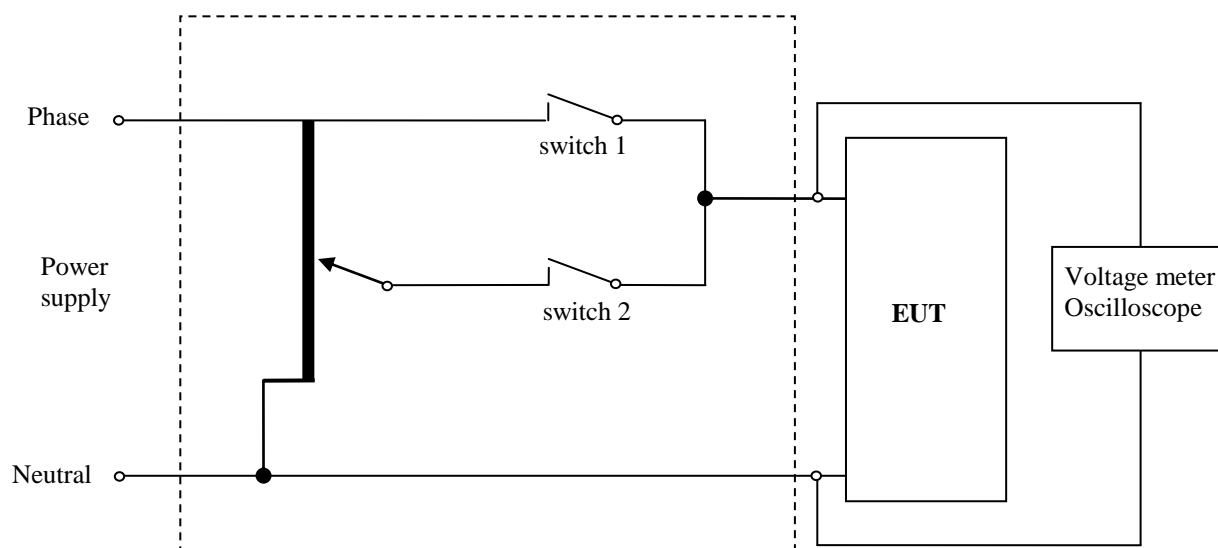

1. The EUT was placed on a ground reference plane (GRP) insulated by an insulating support 0,1 m thick and the GRP was placed on a 0.8m high wooden table for table-top equipment. For floor standing equipment, the EUT was placed on a 0.1m high wooden support above the GRP.
2. The test was performed with the EUT connected to the test generator with the shortest power supply cable as specified by the EUT manufacturer. Changes to the voltage level shall occur at a zero crossing point in the a.c. voltage waveform.
3. The EUT was tested for each selected combination of test level and duration with a sequence of three dips /interruptions with intervals of 10 s minimum. Each representative mode of operation was tested.

5.8.2 Results

Model G45-5.5-27/G12F/112, C37-5.5-27/G12F/112

| Reduction of supply voltage | Test level in % U_T | Duration in parts of period (in ms) | Opinion |
|-----------------------------|-----------------------|-------------------------------------|---------|
| 100% | 0 | 0,5 (10 ms) | B |
| 30 % | 70 | 10 (200 ms) | B |

A: no loss of function.

B: the appliance would not work normally during the test, but after test it would recover.

6 Test setup Photos

Radiated Disturbance Test Setup

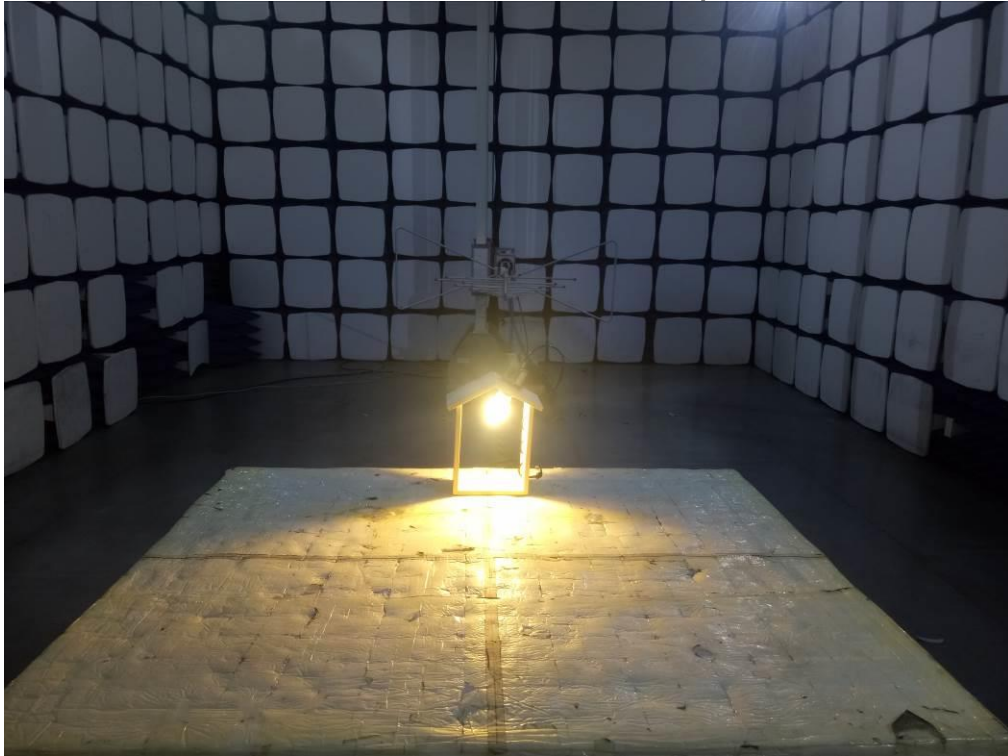

Conducted Emission Test Setup



Radiated Electromagnetic Disturbances Test Setup



Current Harmonics /Voltage Flicker Test Setup

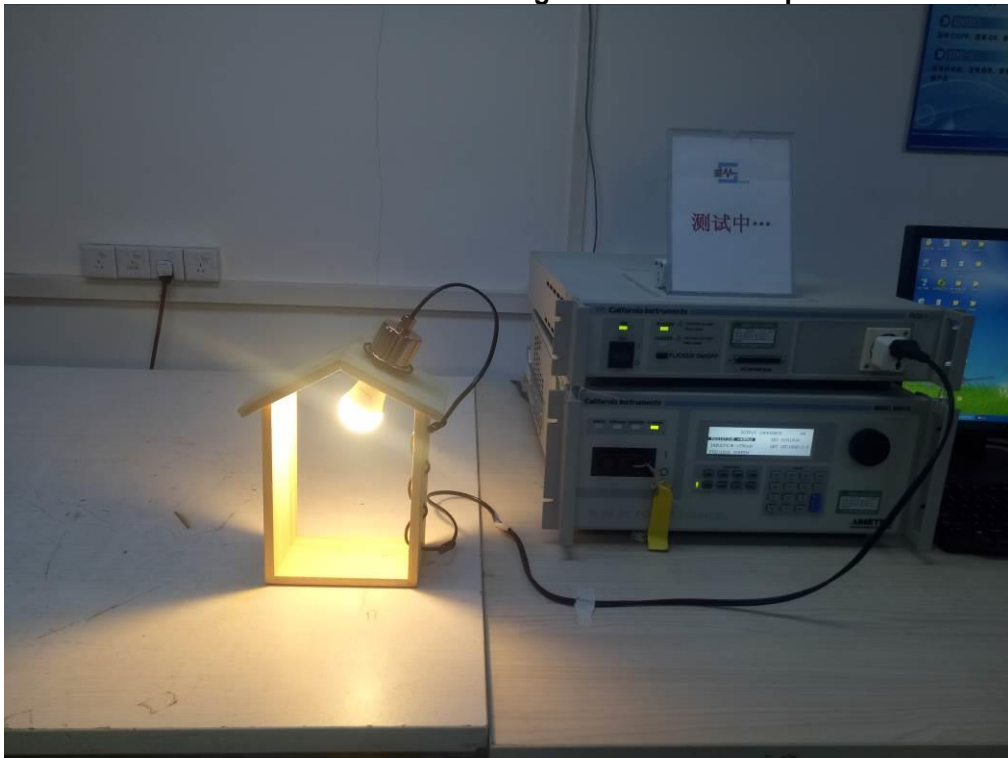

Test Report No.: EFSH18100030-IE-01-E01

Eurofins Product Testing Service (Shanghai) Co., Ltd
No. 395 West Jiangchang Road, Jing'an District, Shanghai, 200436, P.R. China

Electrostatic Discharge Test Setup



Radio Frequency Electromagnetic Fields Test Setup

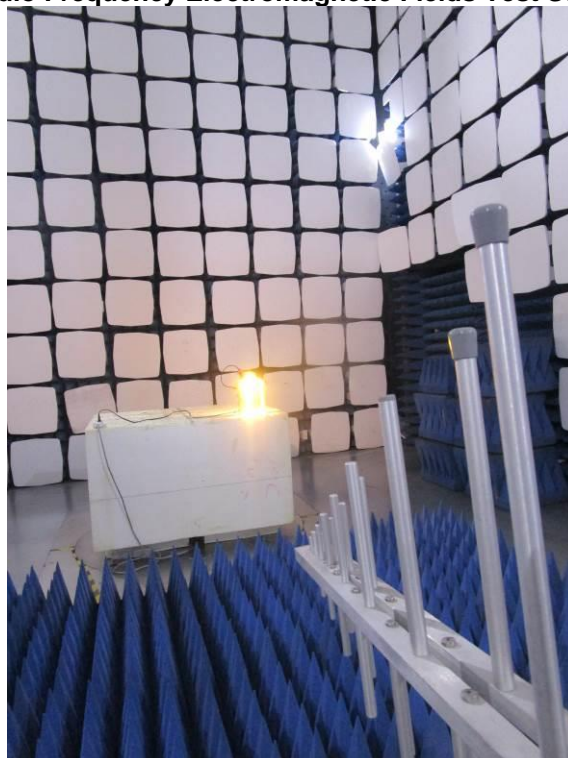

**Electrical Fast Transients Immunity/ Surge Immunity/ Voltage DIPS
and Interruption Test Setup**

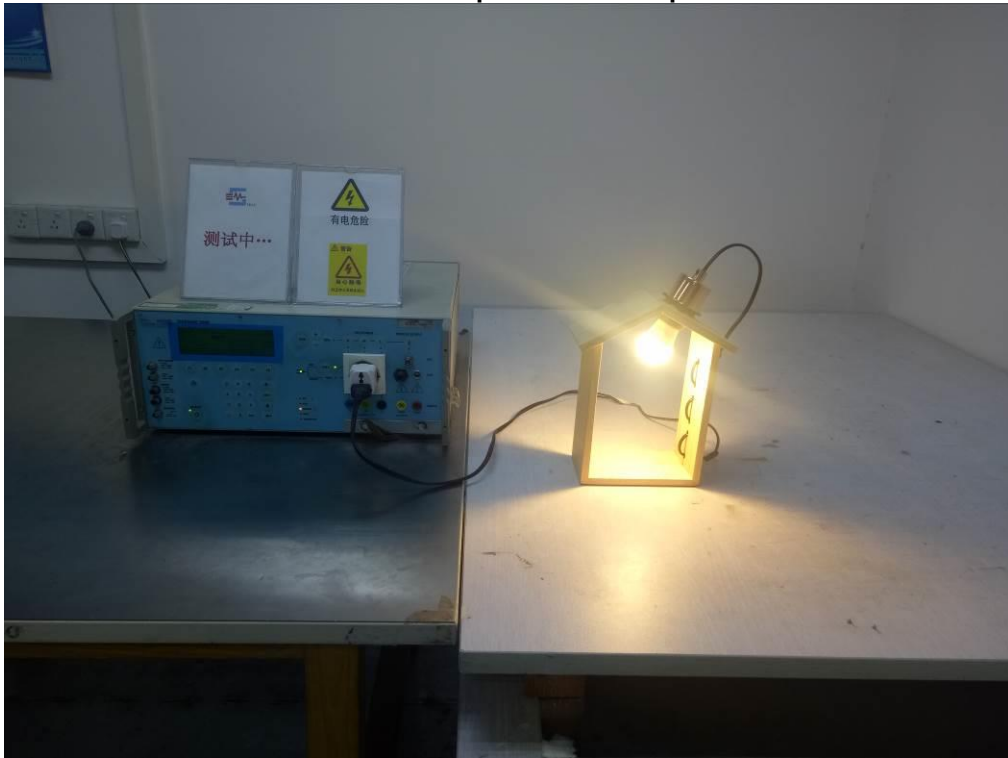

Injected Currents (RF common mode) Test Setup

